

**FACADE
SOLUTIONS**

DESIGN GUIDE



Part of the ROCKWOOL Group

Turning your boldest visions into reality.

Creating places for people to live, work, play and learn in, is a wonderful task. As an architect or planner, you are shaping the world of the future.

Rockpanel provides the assistance you need. We love to inspire you with the most creative designs and innovative features. Our facade solutions enable you to make your design dreams come true and create safe and sustainable buildings. Let's build the future together.

A handwritten signature in blue ink, appearing to read 'J. Ebus', with a stylized, looping flourish at the end.

Jeroen Ebus
Managing Director Rockpanel



Planks

Combine contemporary lines and tradition

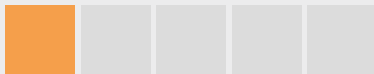

Modern, versatile boards for traditional facade solutions. Easy to use for sidings, classic tongue and groove.

Pages 46-49



Basic applications

A simply great way to renovate

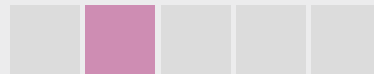

Functional, easy-care facades, soffits and fascias. Ideal for improving and renovating homes.

Pages 50-57



Nature facades

Play around with natural surfaces and designs



Natural looking facades that blend into their surroundings. In harmony with nature and the environment.

Pages 58-67



Design facades

Explore shapes and colours freely

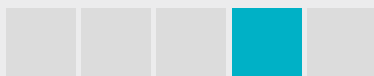

Expressive design facades for impressive buildings. With complete freedom in terms of colour, surface and shape to make every vision a reality.

Pages 68-79



Premium facades

Make a unique statement

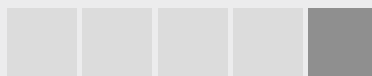

To create something truly incredible, you need complete design freedom. Rockpanel Premium helps you to push all boundaries.

Pages 80-85

Everything you need – and more

Our broad range of facade solution applications provide a clear structure to meet your needs as an architect.

The product division is based on design and technical criteria that are crucial for your building project.

Choose between the different product solutions and decide which facade is ideal for your building.

Table of contents

Overview	2 - 3
Who we are	4 - 11
Design freedom.....	12 - 27
Material performance	28 - 41
Products.....	42 - 85
Accessories.....	86 - 89
Technical information	90 - 157
Product overview.....	158 - 159





Who we are

A scenic landscape at sunset. The sun is low on the horizon, casting a warm, golden glow over the scene. The sky is filled with soft, wispy clouds. In the foreground, there are large, jagged rocks and patches of green grass. The middle ground shows rolling hills and mountains, with a prominent peak in the distance. The overall atmosphere is peaceful and majestic.

**Release the
natural power
of stone to
enrich
modern living**

We have a clear goal.

We want to make stone come alive in all its facets. This is our mission, which represents a new chapter in the history of the ROCKWOOL Group.

Let's start it together!

We are a family.

At the ROCKWOOL Group, we are committed to enriching people's lives. Our range of products reflects the diversity of the world's needs, supporting you in enjoying the comforts of modern living while reducing your carbon footprint along the way.



Rockfon products don't just keep the sound where you want it, they help keep every word or note crisp and clean.



ROCKWOOL thermal insulation helps in providing a safe environment for your little ones.



Our intelligent brake fibres make braking a precise art even in the most difficult conditions.



Our innovative facade solutions give you the freedom to explore the boundaries of your wildest design dreams. So, if you can imagine it, you can build it.



Our precision growing products increase the amount you can grow, improve the quality of what you grow, and limit your operating risks.



Rockpanel HQ

Who we are

Facades made from basalt.

Reliable protection with impressive design.

You have a firm idea of the shape and function of your building.

With Rockpanel, create the facade that corresponds to your idea. We have over 25 years of market experience.

The starting point is the natural raw material from which each of our facade panels is made: basalt.

The volcanic rock basalt is almost unlimited in nature and forms the basis for our stone wool facade panels. The facade panels are recyclable and have an in the ETA confirmed lifetime of 50 years.



This makes Rockpanel a unique, sustainable building material.

Since our facade panels are made of stone wool, they meet the strict requirements for structural fire safety and offer optimum protection for people and the environment.

A Rockpanel facade has many features: It is durable, sustainable, light-weight, easy to install and resistant to the elements.



Each building material has its own strength.

As long as buildings have existed, people have been cladding them. To protect and insulate them and to make them more durable.

And, of course, to give them value and a unique look & feel.

Traditional building materials such as stone or wood may only have a few of the properties that are crucial for facades.

The ideal facade material should combine all these qualities.

Discover Rockpanel.



Just one material has it all. Rockpanel.

Design freedom



More than 200 colours and designs
Customised solutions
Bending and curving
Narrow joints

Fire safety



Contains hardly any combustible materials
Euroclass A2-s1,d0 available
No burning droplets
Free of fire-retardant additives

Installation benefits

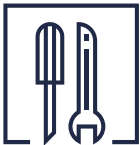

Light-weight
Standard tools suitable
Non-directional
Dimensionally stable

Sustainability



Recyclable
Natural raw material (basalt)
In ETA confirmed lifetime of 50 years
Water-based coating

Durability



Colour and UV-resistance
Insensitive to moisture
Low thermal expansion
Low maintenance
Dirt-resistant







Design freedom

Give colour to your facade.

With more than 200 colours & designs

Through an interplay of colour, finishing and designs, you give your facade a unique effect.

Set your creativity free with over 200 colours and designs.

Or choose your own colour – almost all RAL and NCS colours are available.

Rockpanel Lines²

Pick one of our RAL colours or a ready-to-paint Lines² for an unparalleled interplay of lines

Rockpanel Uni

Choose from a selection of RAL colours for easy and functional applications

Rockpanel Ply

1 ready-to-paint primer for any colour of your choice

Rockpanel Natural

1 puristic design that turns dark brown due to natural weathering

Rockpanel Woods

A wide variety of natural-looking wood designs

Rockpanel Stones

A range of authentic stone designs

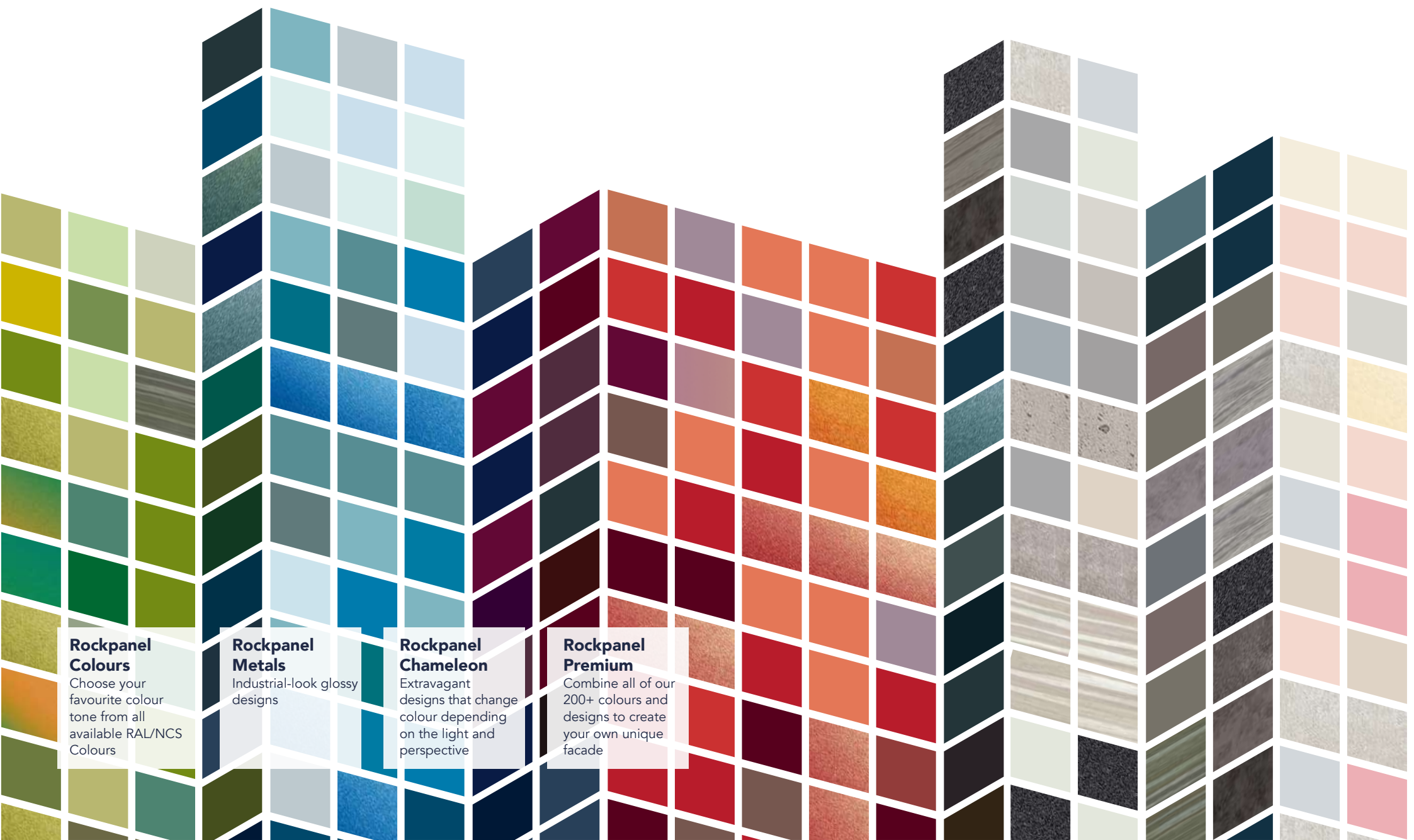

Rockpanel Colours

Choose your favourite colour tone from all available RAL/NCS Colours

Rockpanel Metals

Industrial-look glossy designs

Rockpanel Chameleon

Extravagant designs that change colour depending on the light and perspective

Rockpanel Premium

Combine all of our 200+ colours and designs to create your own unique facade

A modern building with curved glass facades is shown in a wide-angle shot. The building's glass reflects the sky and clouds. A white airplane is flying in the sky, which is filled with soft, white clouds. The ground in the foreground is a dark, textured surface, possibly gravel or asphalt. The overall scene is bright and airy, with a clear blue sky and distant mountains visible on the horizon.

Matt, semi-gloss or high-gloss?

It's up to you!

Pick the finish that best suits your design, or mix different gloss grades for an even greater effect.

Playing with light – a fabulous finish

When realizing your project, you want every detail to be just right. That's why we offer three different gloss grades: matt, semi-gloss and high-gloss. Each level of reflection has its own character. Feel free to play with light to create your own perfect picture. And for an additional dimension, you can even combine our different finishes.



matt

semi-gloss

high-gloss

Versatile interplay of lines on unique facades. Flexible and effective.

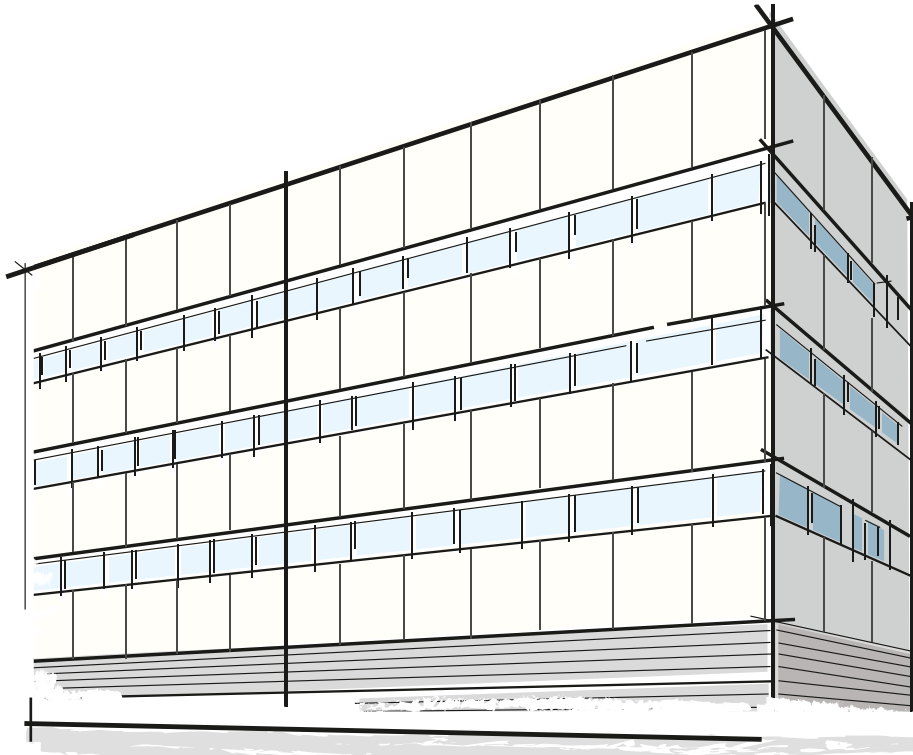

It starts with your building idea

In addition to colour and material, the design of the facade gives your building its character, shapes its surroundings and follows function.

With Rockpanel, you are in control – maximum design freedom at lower costs.



Rockpanel is flexible

If a particular panel format makes sense for your facade design, we make it – customised to your needs.

Thanks to the innovative production process, Rockpanel boards are available in all lengths between 1700 and 3050 mm. You decide which lengths are best for your particular layout.

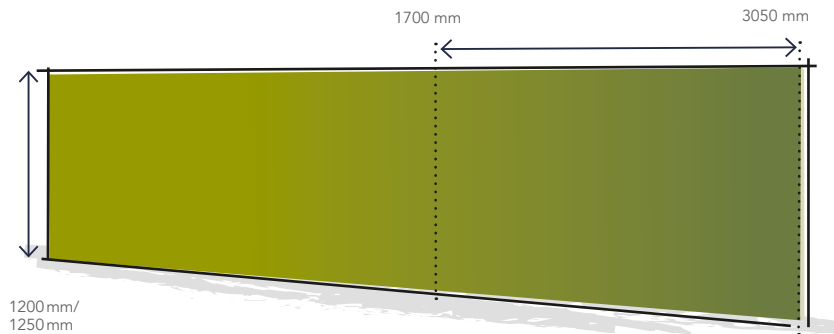
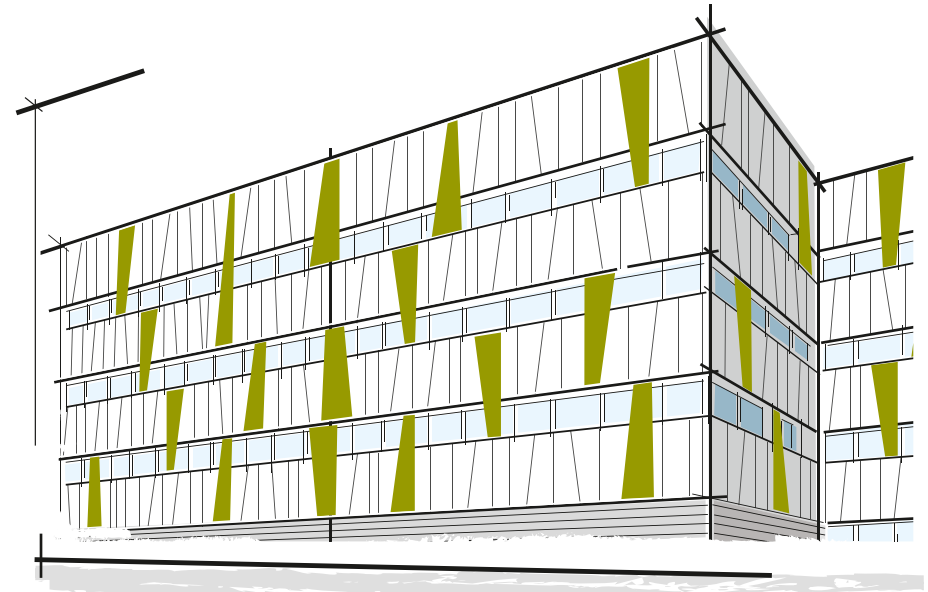
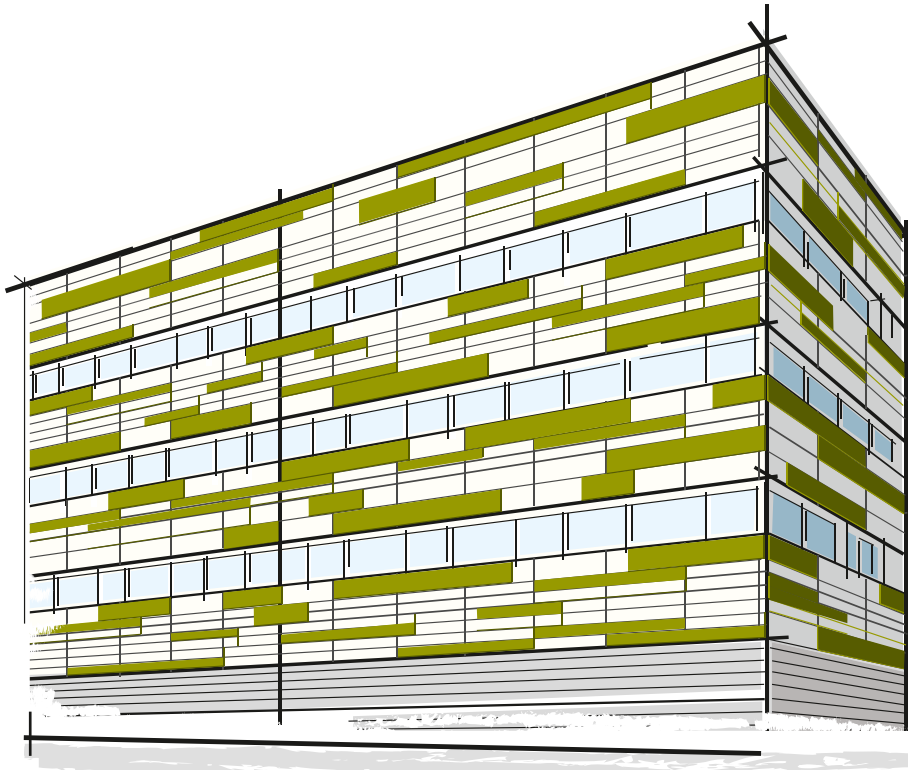

The facade fits into your vision and budget

Rockpanel facade cladding is quick and easy to install. Due to its unique format, it is virtually waste-free and highly cost-effective.

You will always find the solution that is exactly right for your building. Because it simply fits – into your design, your schedule and your budget.





Follow nature. In all its forms.

Naturally bend,
shape and curve

If you feel that nature is the greatest architect, then your decision to go with Rockpanel follows this thinking.

Bend, shape and curve your facade – until a clear picture emerges.

You design it, Rockpanel shapes it.



Design freedom



Play around with light and shade.

Engraving and perforating

Add a third dimension to the design of your facades. Create some additional visual effects and play with light and shadows.

For a fascinating design, for a real statement or a functional element.

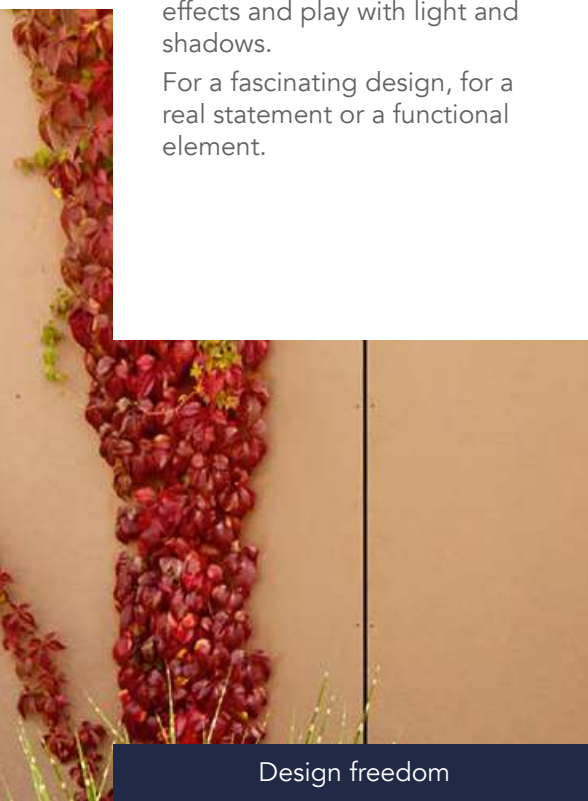

Design freedom

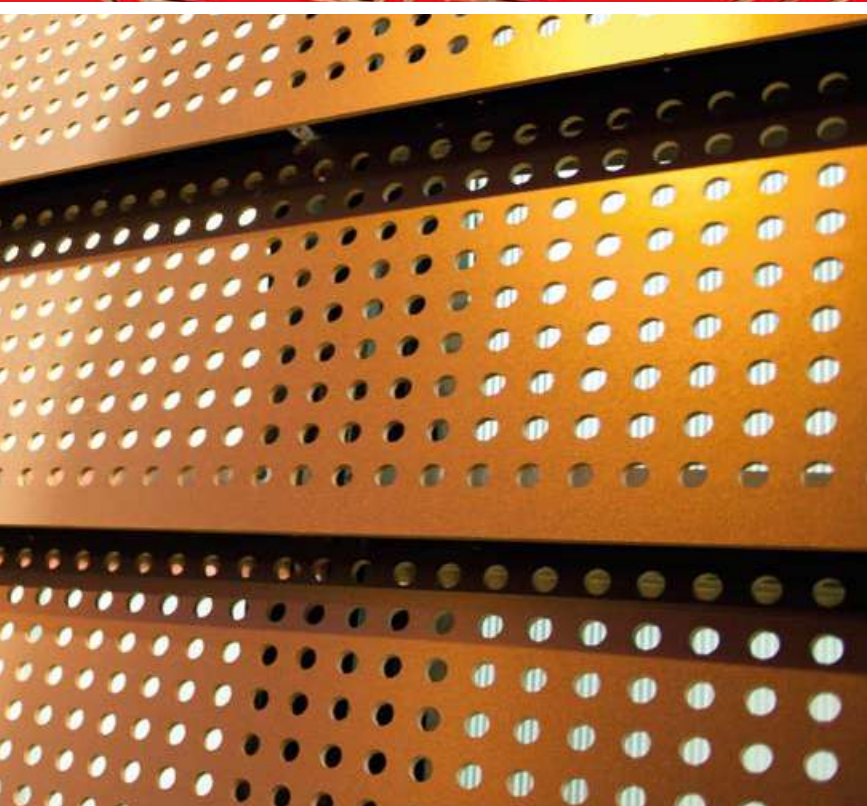

Make a statement with your facade.

Enhance the outer layer of your buildings. Integrate company logos and slogans. Incorporate clear patterns and drawings directly into the facade. Thus, building design and messages become comprehensible – literally in the facade.

Project-specific customer needs and requirements can be met when developing customised design solutions. There are many possibilities for architects in terms of engraving or perforation. We are happy to assist you in realising your idea.

By engraving or perforating the Rockpanel boards you can create a unique facade that plays with light and shadows.

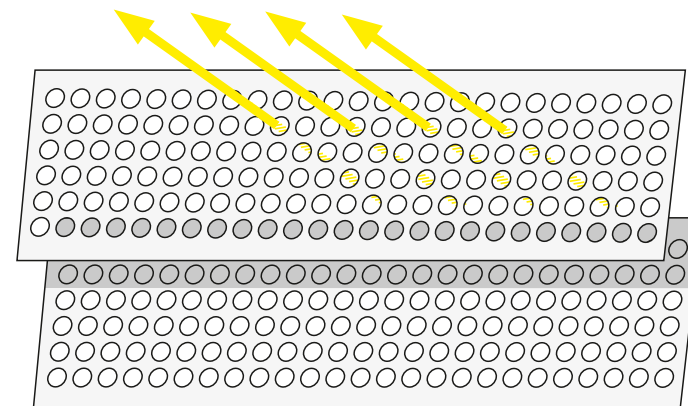

Light can escape through the perforation. Thus, in dark conditions, an attractive visual effect is produced.



Elegance reveals itself. At every angle.

Corners and edges
as design elements

Details are important in order to
implement an idea in the best
possible way.

By choosing the right corner
profile or an invisible fixing,
you can increase the visual appeal
of your facade.

Elegant facades can also have
sharp edges.

Design freedom



Emphasise corners and show edges

Joints and corners give the facade design a definite emphasis and are a clear, formal statement – for a special material.

The edges of Rockpanel facade panels do not need to be treated to protect them from moisture. Opt for a corner solution for purely aesthetic reasons, which gives your design more depth and that extra touch.

You can maintain your creative freedom in the facade design – right down to the smallest corner. With a profile in the panel colour or finishing the edges with matching colour paint. Trims and profiles made of high-quality aluminium are available in nearly all RAL/NCS colours to suit your design.

Depending on the product and fixing, you can choose joint, corner and connecting profiles.

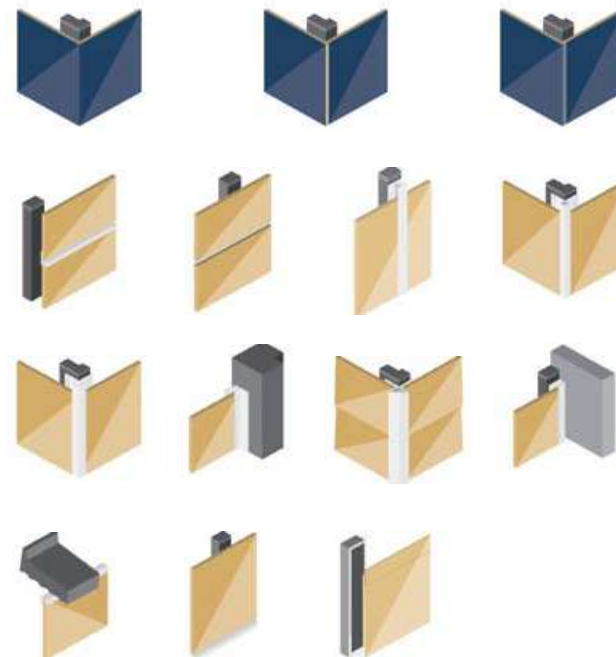

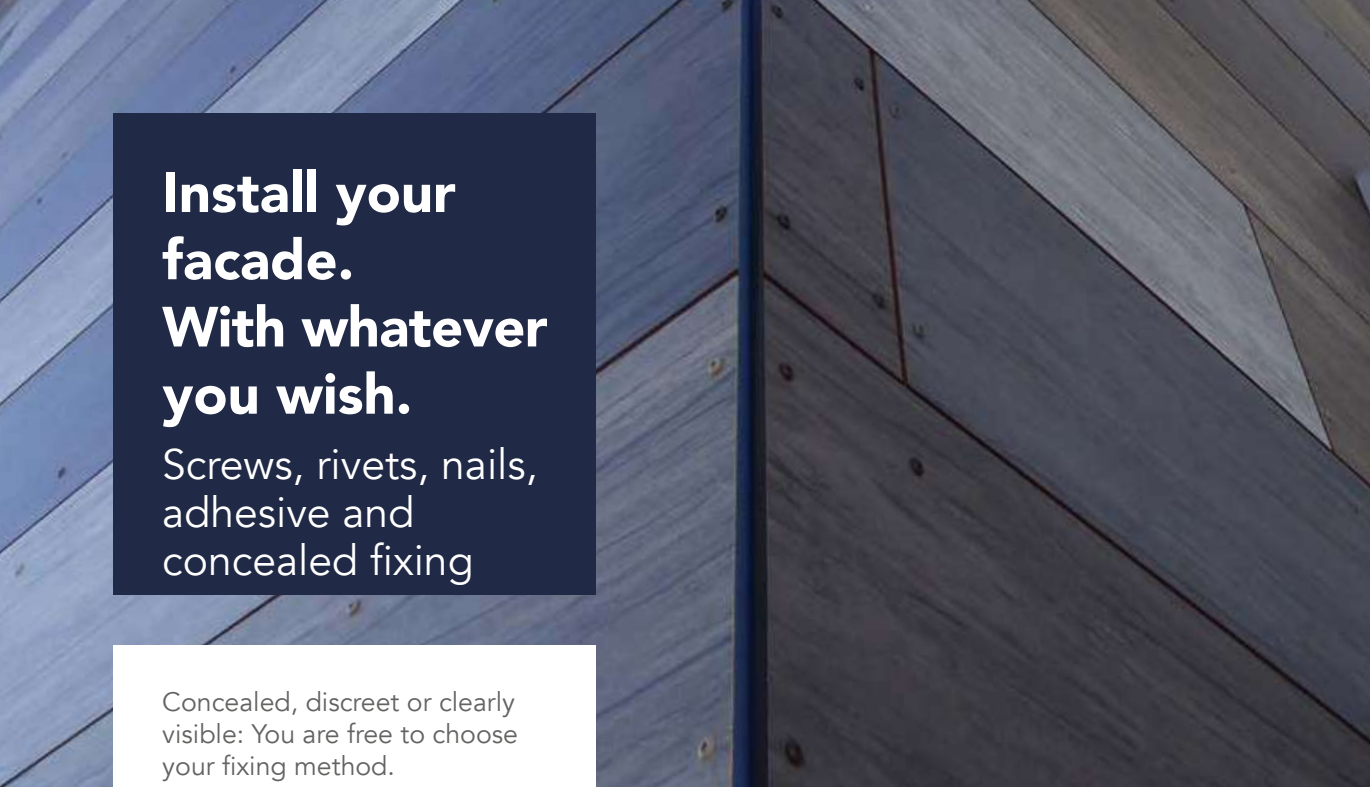

**Install your
facade.
With whatever
you wish.**

Screws, rivets, nails,
adhesive and
concealed fixing

Concealed, discreet or clearly
visible: You are free to choose
your fixing method.

Fixing Rockpanel boards is not
just a technical requirement but
also a design element.



Design freedom



**Screws, rivets, clips and invisible fixing.
You are free to choose.**

Rockpanel boards can be mounted in many different ways.

Screws or rivets are used in visible mechanical mounting. These can be matched to the colour of the facade or deliberately in contrast.

A more subtle, less obvious variant are nails, which are barely visible.

Invisible fixing is also an option: with our Tack-S adhesive system or with EasyFix clips for fast and permanent weatherboarding. Last but not least, we offer a concealed fixing system. This allows you to easily create a flawless facade with invisible mechanical fixing.

Screw fixed to timber



Screws

Rivet fixed to aluminium



Rivets

Nail fixed to timber



Nails

Adhesive system

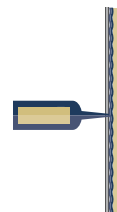

Adhesive method

Weatherboarding

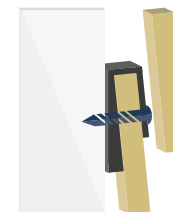

EasyFix Clip

Concealed fixing

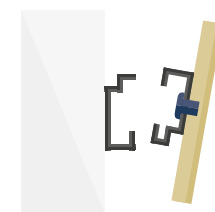

Concealed fixing





Material performance

Rockpanel: the right boards for today's facades. Solutions for the buildings of tomorrow.

Your creativity makes a building unforgettable



Complete design freedom

The facade characterises the building in many ways. This is why maximum design freedom is so important. Combine all of our colours, designs and finishes, anyway you want it. Mix the patterns of Rockpanel Woods or Stones with the effects of Rockpanel Chameleon or Metals.

Consider environmental influences and withstand external forces



Robust and always weatherproof

Whether prolonged and intense sun exposure, snow, frost or continuous rain: A high-quality facade must permanently withstand the elements both visually and mechanically, what is crucial for maximum facade life and requires robust materials.

Be socially and environmentally responsible



Built-in sustainability

In view of climate change, eco-friendly materials are an essential requirement for sustainable construction. Sustainability is a key factor in everything we do. Basalt, the basis material of our boards, is virtually limitless in nature and nearly fully recyclable. A responsible choice, for now and the future.

Plan for the future



Permanently low maintenance

Buildings must remain visually attractive for many decades. Easy maintenance and care is necessary for durability. Next to optimum colour fastness, there's also the increased self-cleaning capacity. This means most of the dirt on the façade is simply washed away by rainwater.

Ensure safety



Reliably fireproof

Rockpanel boards are available as Euroclass A2 – the responsible choice for high-rise and high-risk buildings. Safety comes first. No compromises.

Easy handling



Expand your creative space

As Rockpanel boards are robust yet flexible and light-weight, the panels are easy to mount. And it can all be done with standard tools such as hand saws, circular saws, jigsaws and drills.

Build as we do, in the right way.

All Rockpanel products are sustainable – by nature.

Like all ROCKWOOL products, they are made from basalt, a raw material that is virtually unlimited in its availability and is renewable in the production cycle.

We are also continuously working on contributing to a healthy environment and a sustainable use of resources at every stage of the life cycle of our products.



Sustainable from start to finish.

Sustainability is a key factor in everything we do. We want to help build a better world and take good care of the earth for future generations. But how do we contribute to this?

Efficient manufacturing process

The starting point is the raw material from which all our facade panels are made: basalt. This volcanic rock is both readily available and sustainable – the earth creates 38000 times more basalt each year than we are using.

Thanks to our unique and highly efficient manufacturing process, we are able to produce more than 400 m² Rockpanel boards from only 1 m³ of basalt. In our factories and office buildings, we only use 100 % green electricity. Production waste is fully utilised, and up to 50 % of our raw material content are recycled materials.

Certifications

We have an externally verified Environmental Product Declaration (EPD according to EN15804), verified by IBU, which shows great environmental performance of Rockpanel facade panels.

Rockpanel production is certified to ISO 14001. All Rockpanel facade boards have an official ETA confirmed lifetime of 50 years.

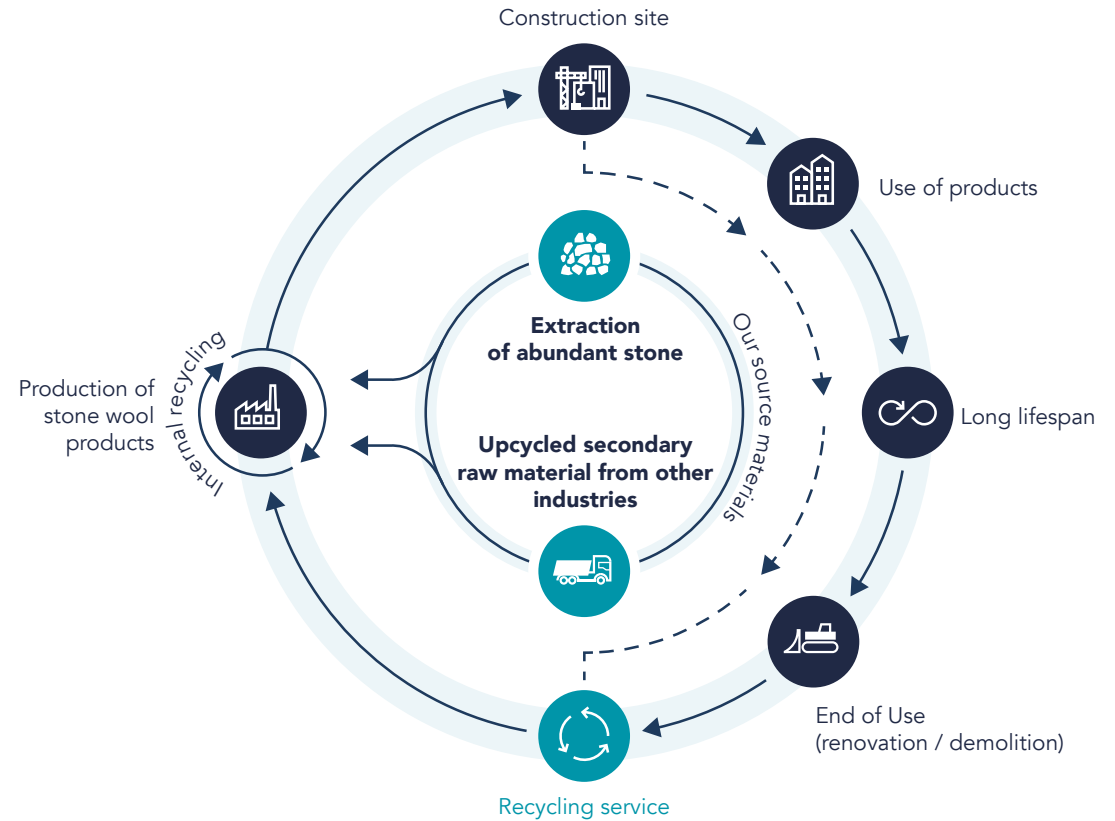

Source material

- Basalt: natural and plentiful supply
- Use material sources located close to the production site
- Up to 50 % recycled content

Assembly and use

- Safe & easy to use
- Low maintenance
- High level of fire safety
- Moisture and temperature resistant
- In ETA confirmed lifetime of 50 years

Production process

- Production waste is completely recycled
- More than 400 m² of facade panels can be produced from 1m³ of basalt
- Water-based coating systems
- Recycling plants
- ISO 14001 certified
- Use of renewable energy

Recycling

- Almost completely recyclable
- No loss of quality

Safety comes first. No compromises.

At Rockpanel, we feel everyone deserves to be in a safe environment. No matter where you live, work, play or learn: safety comes first.

Making the right choices therefore is essential. To ensure fire safety in high-risk and high-rise buildings, we should all work together. Each and every one of us should take responsibility and do their part.

It's part of our mission to use the power of stone to improve people's safety. That's why we offer facade cladding that is fire resilient by nature.

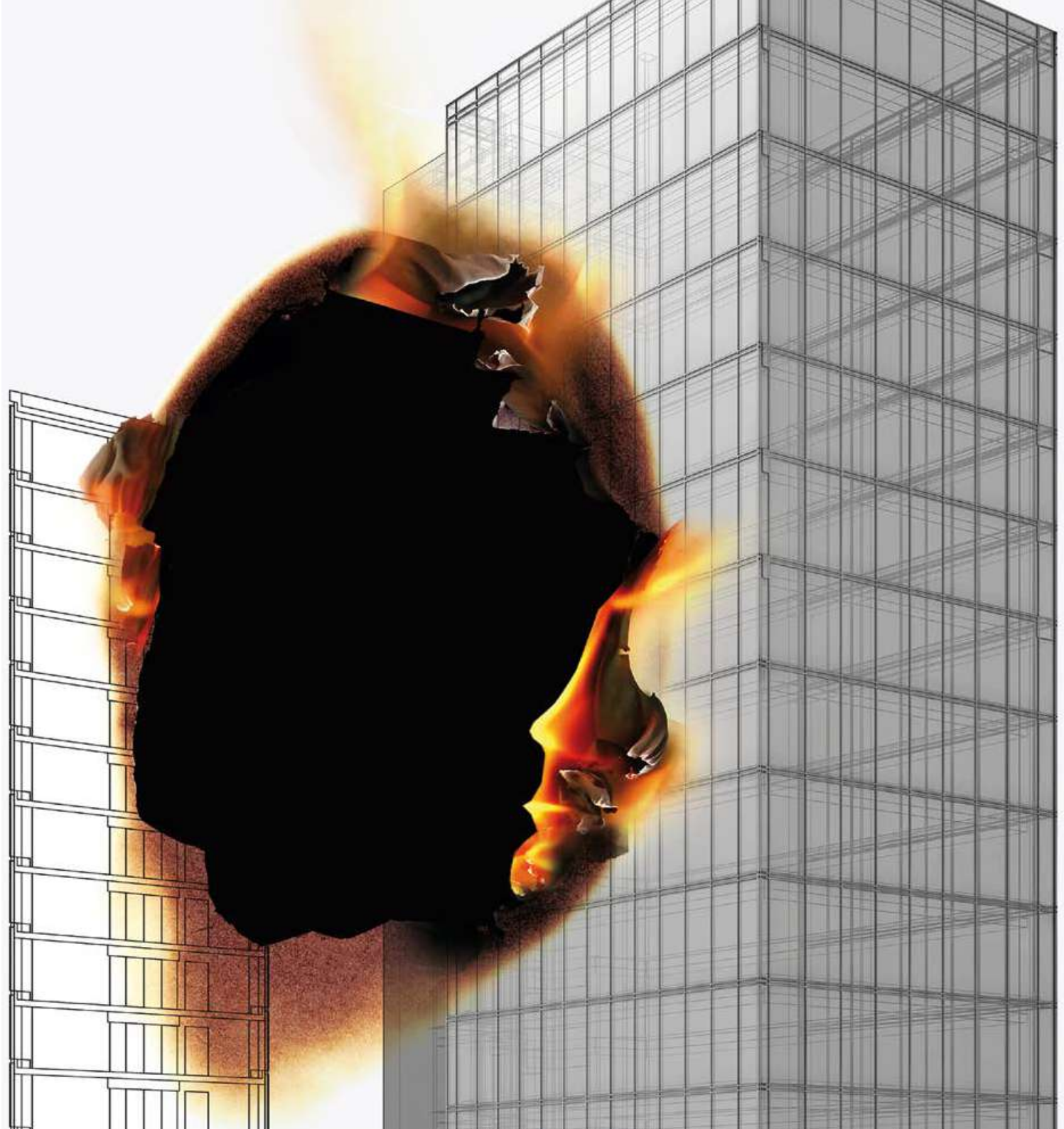

Enjoy design freedom. With integrated fire safety.

Fire safe as standard

Do not compromise between design and fire protection when realising your building idea.

Rockpanel facades are by nature durable, weather-resistant and robust. Because they are made of stone wool, they can withstand particularly high temperatures.

In the event of a fire, Rockpanel facade panels do not cause the fire to spread because no combustible parts can peel off or drop off.

Fire Safety

The Euroclass-classification of all Rockpanel products is based on testing with non-combustible mineral wool insulation. For the field of application covered by the classification please see the relevant Declaration of Performance.

Completely non-combustible

For all high-rise and high-risk buildings we recommend the use of non-combustible facade panels and insulation with a minimum classification of A2-s1,d0 according to EN 13501-1.

Rockpanel A2 cladding gives each building a unique style and does not compromise when it comes to fire safety.

Rockpanel A2 facade panels used in combination with non-combustible insulation materials, e.g. ROCKWOOL stone wool, ensure that your building meets all the national building regulations.

With an aluminium or steel sub frame, this combination meets the requirements of the European Reaction to Fire classification system and can therefore be classified as non-combustible, according to national building codes.

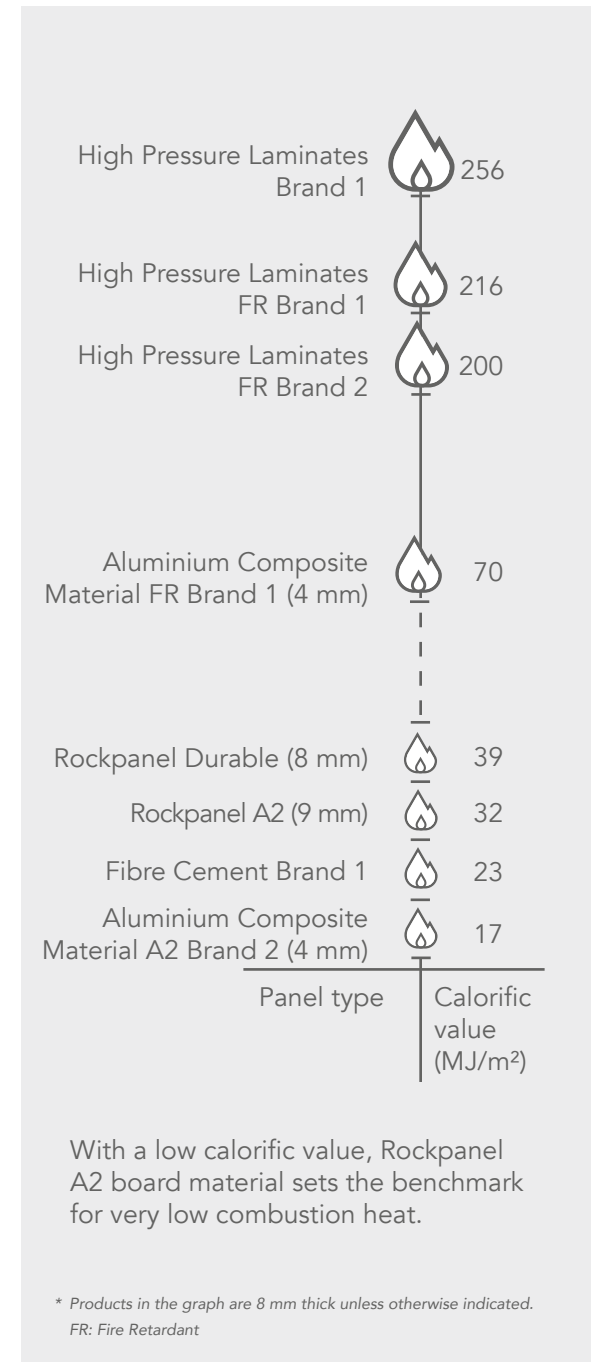

Brave the elements. In the most beautiful way.

With a ventilated facade, you can protect the exterior insulation and the inside of your building from sun, rain and moisture.

The Rockpanel boards themselves are also equipped for all weather conditions.

The surface permanently resists sun, wind and rain. This keeps the facade beautiful for the years to come. And in addition, Rockpanel boards are low-maintenance.

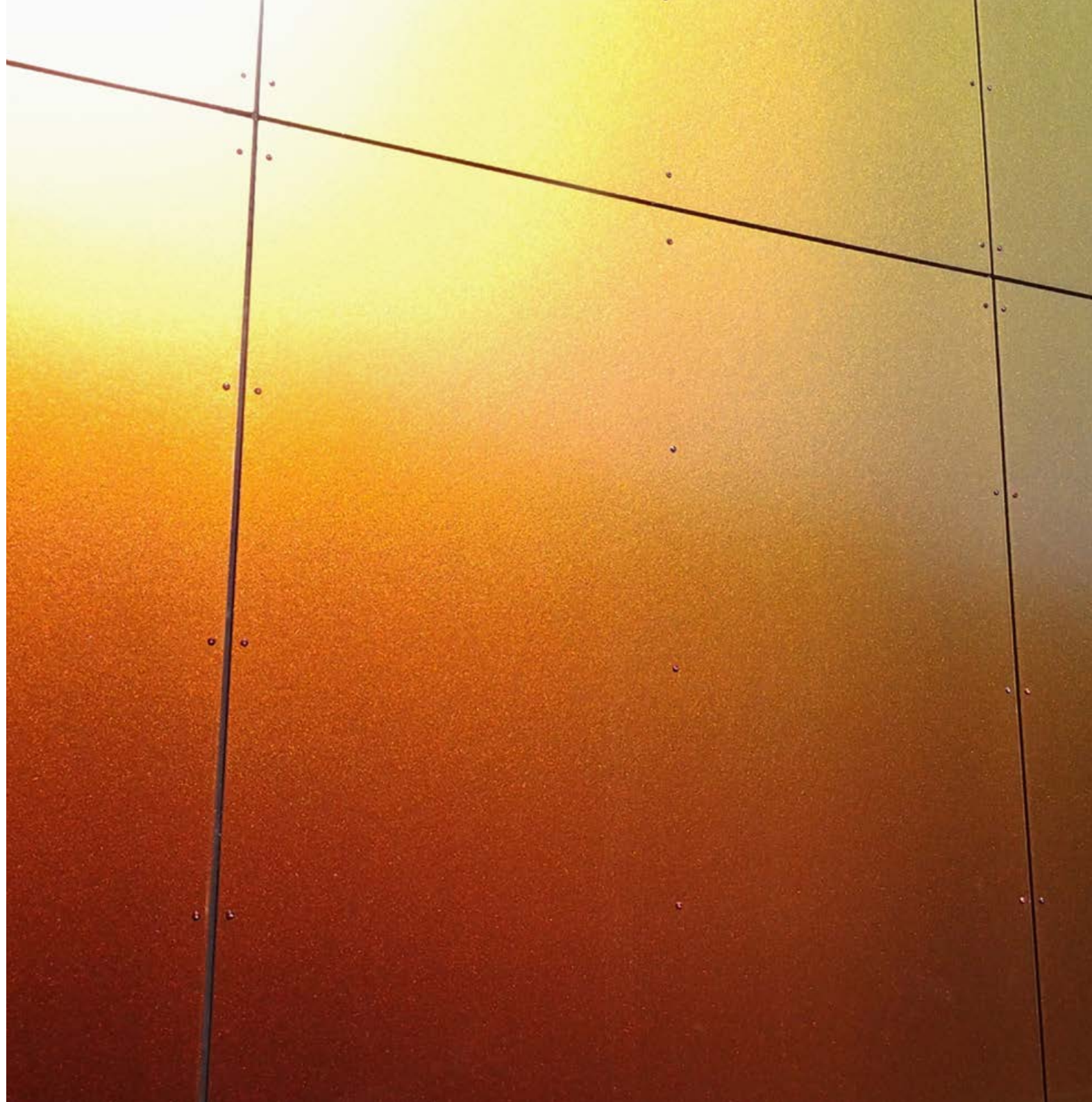

Protected for a long time. Easy to maintain.

Naturally easy to look after

All Rockpanel facade panels are manufactured with a water-based coating - except Rockpanel Natural and Rockpanel Ply.

This coating protects your facade against the effects of UV radiation and preserves the colours for years.

We have made our facades so easy to maintain that one wash a year with water is enough.

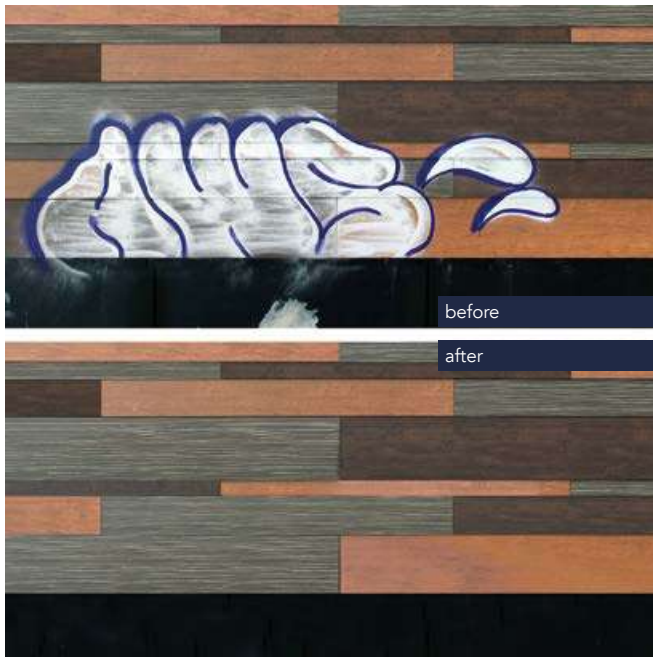

Even more protection with ProtectPlus

ProtectPlus gives your facade extra protection. This transparent layer further strengthens the UV resistance and offers increased self-cleaning capacity. That means most of the dirt on the facade is simply washed away by rainwater. Due to its properties even graffiti can be removed!

Rockpanel Premium, Woods, Stones, Chameleon and Metals (except Aluminium White and Aluminium Grey) are coated with ProtectPlus as standard.

Rockpanel Colours can be optionally finished with a ProtectPlus layer.

For information on maintenance and cleaning see the 'Cleaning & Maintenance' documentation on our website.

Warranty

Rockpanel offers a 10 year project guarantee on the following product ranges: Rockpanel Lines², Uni, Structures, Colours, Woods, Stones, Metals and Chameleon.

On Rockpanel Premium we even offer a 15 year project guarantee. The products should be handled conform our prescriptions regarding storage, handling and cleaning in a normal atmospheric environment. To obtain this guaranty, it is necessary to register your project with us. Please apply for our specimen guarantee certificate in case you wish to obtain further details.

Ready for any environmental influences.

Create harmonious facades with minimal joint widths.

Rockpanel facades leave no room for the effects of temperature, humidity or rain.

One of the strengths of our base material is that the panels retain their dimensions and properties under all conditions.



Unrivalled stability in terms of expansion. Unaffected by moisture.

Horizontal and vertical joints

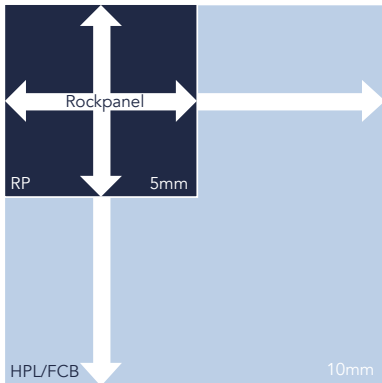

Linear expansion coefficient

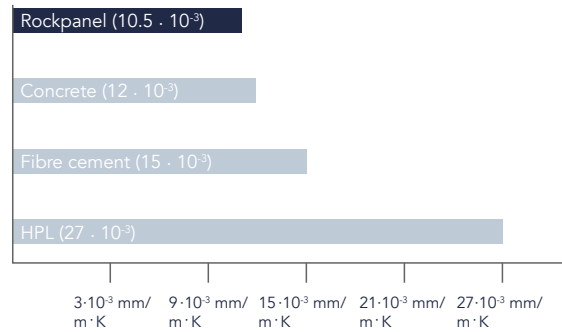

Highly resistant

Thanks to the source material basalt, Rockpanel facade panels are dimensionally stable. Extreme temperature or humidity fluctuations cause practically no change to the length or width of the panels.

Because the coefficient of expansion is even lower than that of concrete, Rockpanel boards undergo hardly any dimensional change.

It is possible to work with narrow joints of 5-6 mm, and in some applications, joint-free assembly is even possible.

Moisture resistant

The effects of moisture are not an issue with Rockpanel facade panels. Finishing the edges to protect them from moisture is not necessary.

Any moisture that is absorbed is released directly into the environment without any change to the boards mechanical or optical properties.

Make the installation easy.

The safe, efficient and fast handling of building materials is an important issue in the cladding of facades.

Rockpanel boards are as durable as stone and as easy to work with as wood.

They are very light and can be machined quickly and easily using standard tools.

This saves installation time and makes your building more economical, without compromising on design, shape or functionality.



Easy to work with. Quick to build.

Working with standard tools

Rockpanel boards are as sturdy as stone, but can still be handled effortlessly. Because it is much faster to cut, finish and detail on site than with other sheet materials, you save time and money during installation. Conventional tools such as high-quality hand saws, circular saws or jigsaws are all suitable.

Easy to install

Installing the facade becomes an easy matter – Rockpanel facade panels are much lighter than conventional cladding boards.

For example, a standard 8 mm Rockpanel board weighs only 8.4 kg/m², which is of enormous advantage when it comes to handling on the building site, on-site operations and mounting on the building itself.

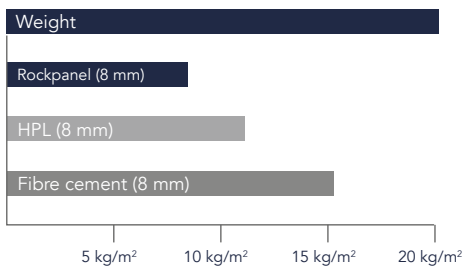
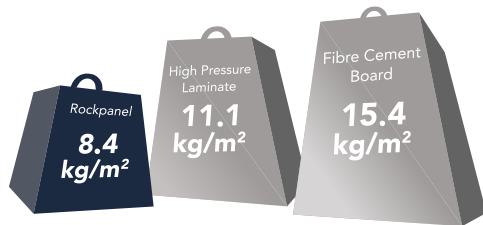

Shine with detailed solutions

Every design and every solution for the facade or roof can be quickly and easily implemented using Rockpanel boards.

They can be quickly and easily screwed together, riveted, nailed and even glued. You simply cut the facade panels to size and fix them.







Products

What do you need for your design?

As an architect, you start with an idea or theme. The materials you use should complement your needs, not limit them.

With our facade solutions, we make it easier for you to implement your ideas. It doesn't matter if you're going for functionality, a natural look or a prestigious design.

Our ultimate goal is to help and inspire you to make your design dreams come true. You will always find a solution within our five segments that matches your architectural vision.



Planks

Combine contemporary lines and tradition

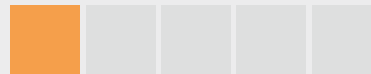

Modern, versatile boards for traditional facade solutions. Easy to use for sidings, classic tongue and groove.



Basic applications

A simply great way to renovate

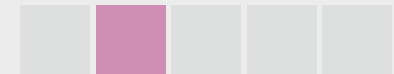

Functional, easy-care facades, soffits and fascias. Ideal for improving and renovating homes.



Nature facades

Play around with natural surfaces and designs



Natural looking facades that blend into their surroundings. In harmony with nature and the environment.



Design facades

Explore shapes and colours freely

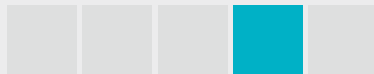

Expressive design facades for impressive buildings. With complete freedom in terms of colour, surface and shape to make every vision a reality.



Premium facades

Make a unique statement

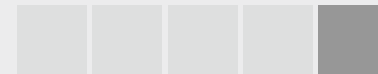

To create something truly incredible, you need complete design freedom. Rockpanel Premium helps you to push all boundaries.

Planks

Combine contemporary
lines and tradition

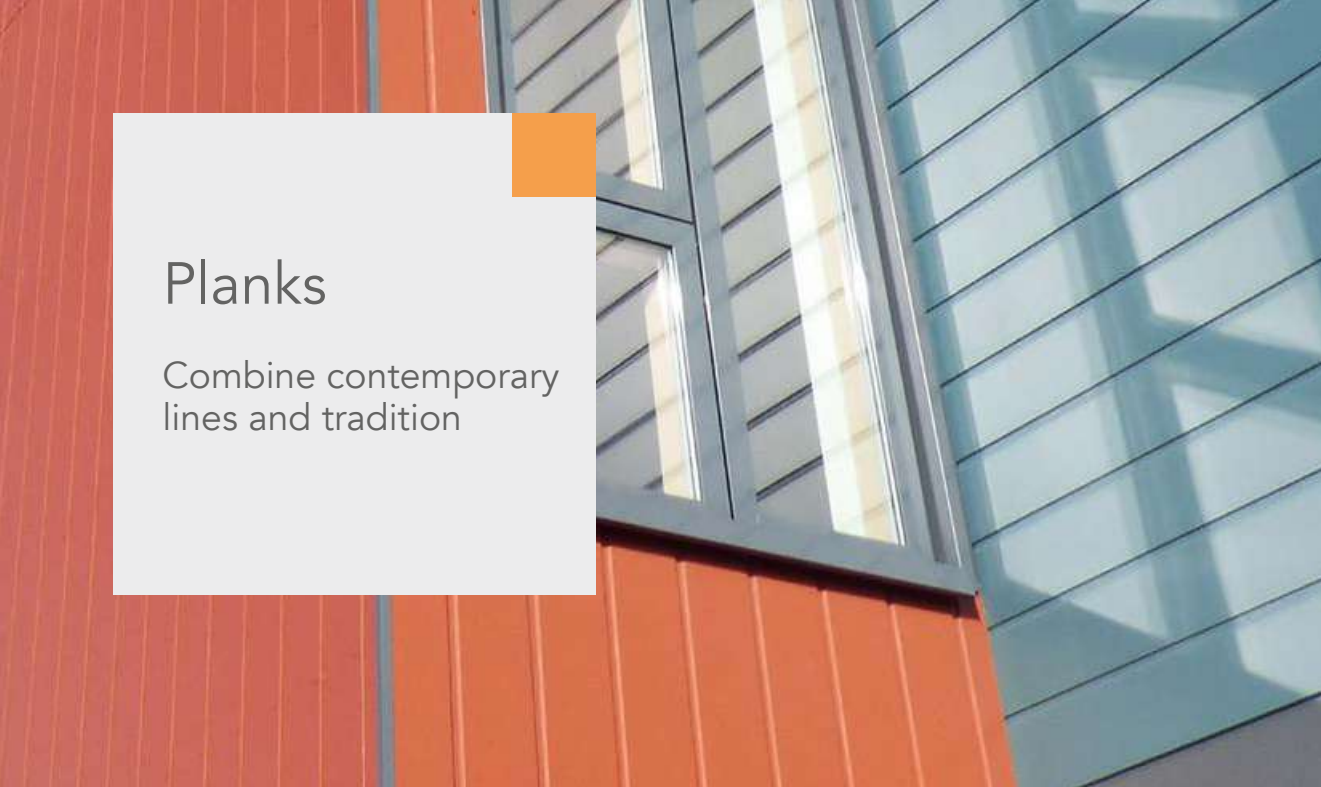

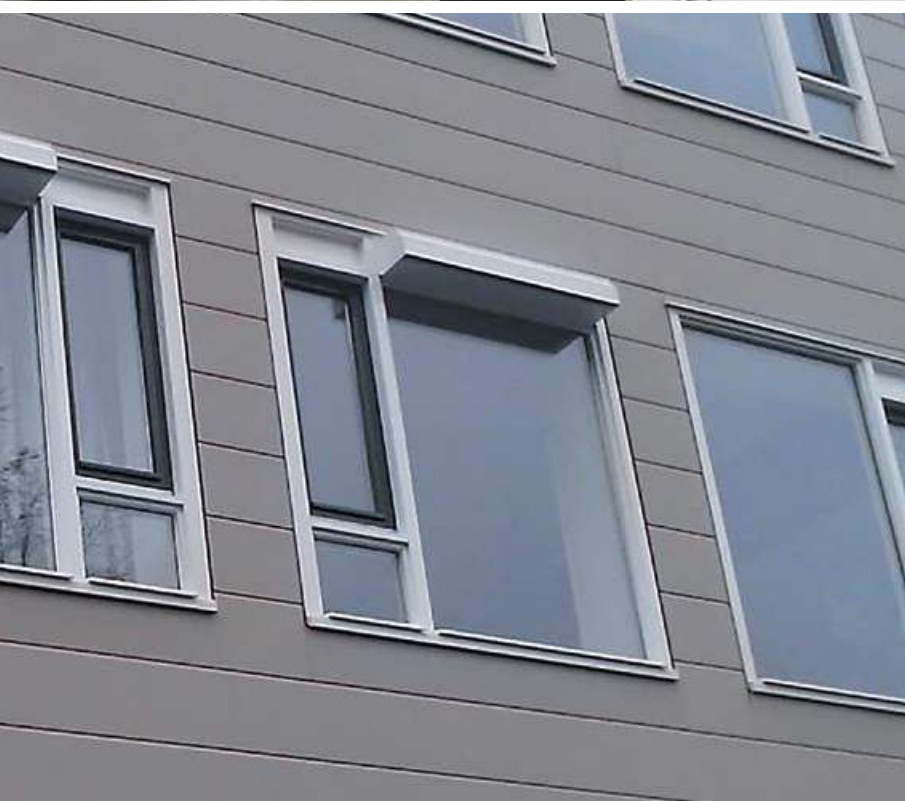



Rockpanel Lines².
When lines are required.

Play around with traditional facade designs – use lines as a continuous element or to provide a stylish touch. With Rockpanel Lines² you can take the liberty to reinterpret the classic tongue and groove profile. Versatile, durable, easy to maintain and cost-effective.

Rockpanel Lines²

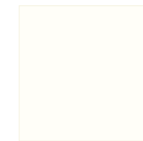

RAL 9010

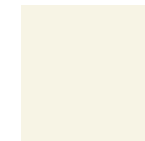

RAL 9001

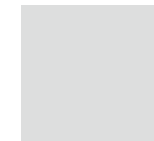

RAL 7004



RAL 1015



RAL 7016

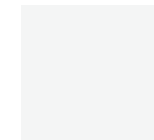

Grey (ready-to-paint primer)

Assortment

Product Line	Board Composition	Thickness	Standard dimensions	Working width
Rockpanel Lines ²	Durable	10 mm	164 (S) /295 (XL) x 3050 mm	146 (S) /277 mm (XL)

Key product properties

Rockpanel Lines ²	Rockpanel Lines ² 10 mm	Unit	Test/classification method
Optical properties			
Colour stability (5000 h)	3-4 or better	Grey scale	ISO 105 A02
Fire			
Fire classification	B-s2,d0	Euroclass	EN 13501-1

The Euroclass-classification of all Rockpanel products is based on testing with non-combustible mineral wool insulation. For the field of application covered by the classification please see the relevant Declaration of Performance. For high-rise buildings and high-risk buildings Rockpanel recommends the application of non-combustible (Euroclass A1 or A2) cladding and insulation.

Physical properties			
Thickness	10	mm	EN 325
Weight	10.5	kg/m ²	
Density, nominal	1050	kg/m ³	EN 323
Thermal conductivity	0.37	W/m·K	EN 10456
Water vapour permeability S _d (at 23 °C and 85 % RF) Colours	*	m	EN 12572
Coefficient of thermal expansion	9.7	x 10 ⁻³ mm/m·K	EN 438:2 clause 17
Coefficient of moisture expansion (after 4 days)	0.302	mm/m	EN 438:2 clause 17
Mechanical properties			
Bending strength, length and width (f _{0g})	27	N/mm ²	EN 310 / EN 1058
Modulus of elasticity m(E)	4015	N/mm ²	EN 310

* not applicable non-ventilated

Fixing distances

Maximum Fixing distances (mm)	Rockpanel Lines ² 10 mm	
	b max.	a max.
Nail	600	146/277
Screw	600	146/277

Lines²

Combine contemporary
lines and tradition
10 mm



- Available in 2 widths (S and XL)
- Dimensionally stable
- Robust and durable
- Easy to install
- Use standard carpentry tools
- Low maintenance

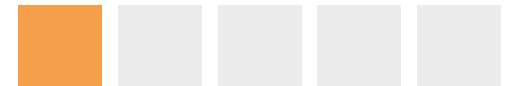



Basic applications

A simply great way to renovate

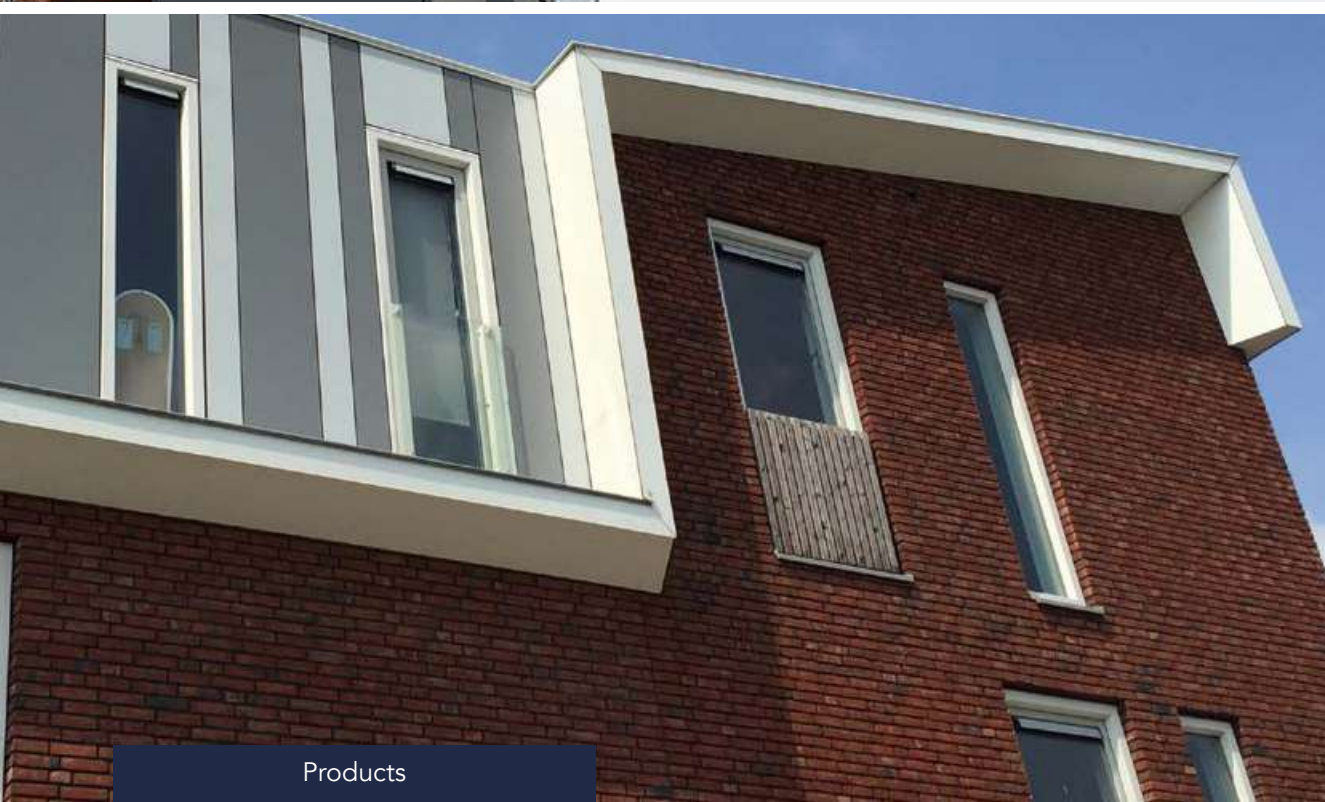





Functional and easy to maintain. An easy way to add beauty and value to your house.

Give each building a fresh, high-quality look. Easy to install and functional, whether improving or renovating:
Rockpanel basic solutions are robust, easy-to-maintain facades and roof line cladding – for every budget.

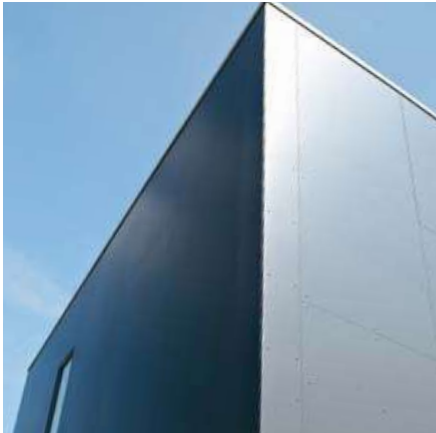

Rockpanel Uni

Clear style and durability –
Rockpanel Uni suits every budget,
every time.



Rockpanel Ply

Choose colour-free – simply paint
Rockpanel Ply any shade you like.

Basic applications

A simply great way
to renovate

Quick & easy installation for a beautiful result

- Easy to (re-)paint
- Durable
- Easy to install
- Use standard carpentry tools
- Light-weight
- Moisture resistant
- Low maintenance

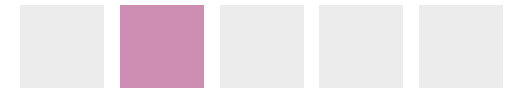



Rockpanel Uni.
Beauty can be that simple.

Timeless architectural concepts are characterised by clarity. If your design idea involves a lot of functionality, then Rockpanel Uni is just the thing for you. Long lifetime, quick to install – suitable for facades and roof line – and fits into every budget.

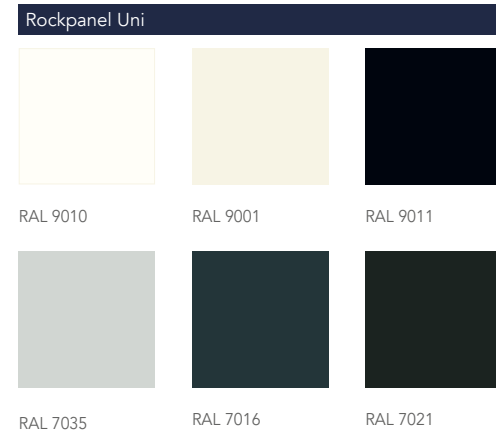

Assortment

Product Line	Thickness	Standard dimensions
Rockpanel Uni	6 mm	1200 x 2500/3050 mm

Key product properties

Rockpanel Uni	Rockpanel Uni 6 mm	Unit	Test/classification method
Optical properties			
Colour stability (5000 h)	3 or better	Class on greyscale	ISO 105 A02
Fire			
Fire classification	B-s2,d0	Euroclass	EN 13501-1
The Euroclass-classification of all Rockpanel products is based on testing with non-combustible mineral wool insulation. For the field of application covered by the classification please see the relevant Declaration of Performance. For high-rise buildings and high-risk buildings Rockpanel recommends the application of non-combustible (Euroclass A1 or A2) cladding and insulation.			
Physical properties			
Thickness	6	mm	EN 325
Weight	6.3	kg/m ²	
Density, nominal	1050	kg/m ³	EN 323
Thermal conductivity	0.37	W/m·K	EN 10456
Water vapour permeability S _d (at 23 °C and 85 % RF) Colours	< 1.8	m	EN 12572
Coefficient of thermal expansion	10.5	x 10 ⁻³ mm/m·K	EN 438:2 clause 17
Coefficient of moisture expansion (after 4 days)	0.303	mm/m	EN 438:2 clause 17
Mechanical properties			
Bending strength, length and width (f ₀₅)	≥ 24	N/mm ²	EN 310 / EN 1058
Modulus of elasticity m(E)	3567	N/mm ²	EN 310

Fixing distances

Maximum Fixing distances (mm)	Rockpanel Uni 6 mm	
	b max.	a max.
Nail	400	300
Screw	400	300

Uni

Upgrade or renovate
your house.
6 mm



- Easy to install
- Vapour-permeable
- Moisture resistant
- Use standard carpentry tools

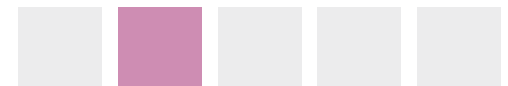



**Rockpanel Ply.
Simply apply the colour of your choice.**

Is the exact colour you would like for your design not available in our range, or do you want to accentuate even the smallest detail of the building? Rockpanel Ply gives you the freedom to express yourself in any colour. It is a durable, sturdy base for your desired colour. And at the same time a sustainable alternative to wood.

Ready for your painting ideas.

They are pre-primed and very easy to finish. Our facade panels can be painted to your liking using standard colours from other manufacturers.

Basic Primer

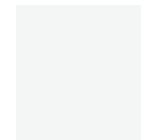

Grey (ready-to-paint primer)

Assortment

Product Line	Board Composition	Thickness	Standard dimensions
Rockpanel Ply	Ply	8 mm	1200 x 2500/3050 mm

Key product properties

	Rockpanel Ply 8 mm	Unit	Test/classification method
Optical properties			
Colour stability (5000 h)	N/A	Class on greyscale	ISO 105 A02
Fire			
Fire classification	B-s2,d0	Euroclass	EN 13501-1

The Euroclass-classification of all Rockpanel products is based on testing with non-combustible mineral wool insulation. For the field of application covered by the classification please see the relevant Declaration of Performance. For high-rise buildings and high-risk buildings Rockpanel recommends the application of non-combustible (Euroclass A1 or A2) cladding and insulation.

Physical properties			
Thickness	8	mm	EN 325
Weight	8	kg/m ²	
Density, nominal	1000	kg/m ³	EN 323
Thermal conductivity	0.35	W/m·K	EN 10456
Water vapour permeability S _d (at 23 °C and 85 % RF) Colours	*	m	EN 12572
Coefficient of thermal expansion	9.7	x 10 ⁻³ mm/m·K	EN 438:2 clause 17
Coefficient of moisture expansion (after 4 days)	0.241	mm/m	EN 438:2 clause 17
Mechanical properties			
Bending strength, length and width (f ₀₅)	≥ 15	N/mm ²	EN 310 / EN 1058
Modulus of elasticity m(E)	3065	N/mm ²	EN 310

* The S_d value will change when applying the final colour, the board cannot be mounted non-ventilated.

Fixing distances

Maximum Fixing distances (mm)	Rockpanel Ply 8 mm	
	b max.	a max.
Nail	500	400
Screw	500	500

Ply

Basic application.
Ready for painting.
8 mm



- Primed surface ready to paint
- Vapour-permeable
- Moisture resistant
- Use standard carpentry tools

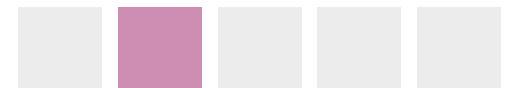

Nature facades

Play around with
natural surfaces
and designs

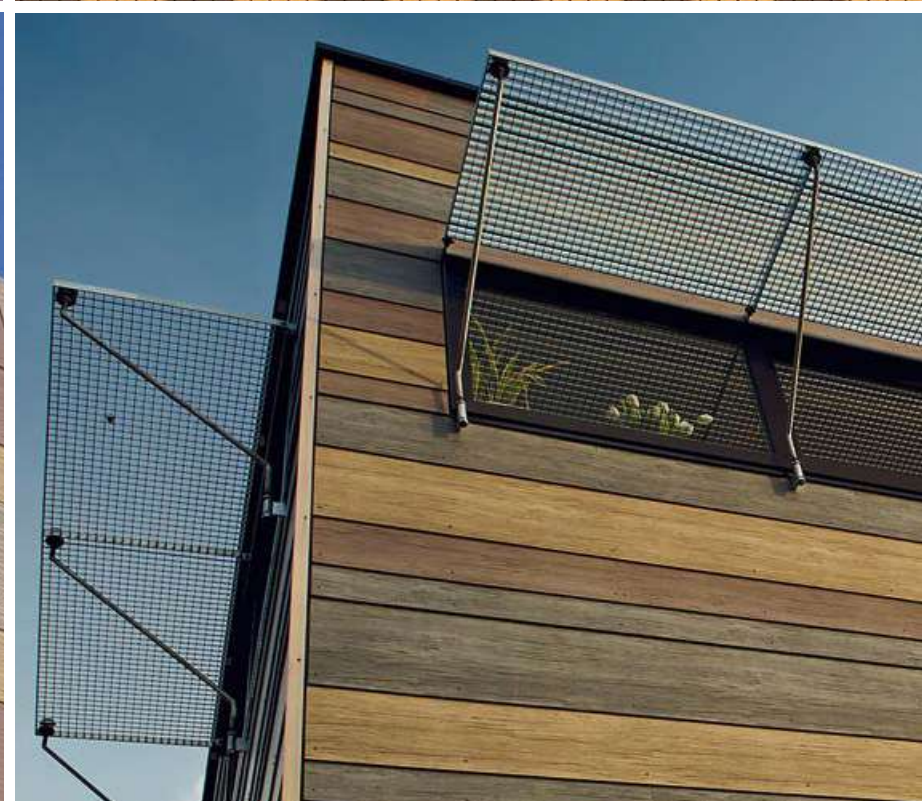
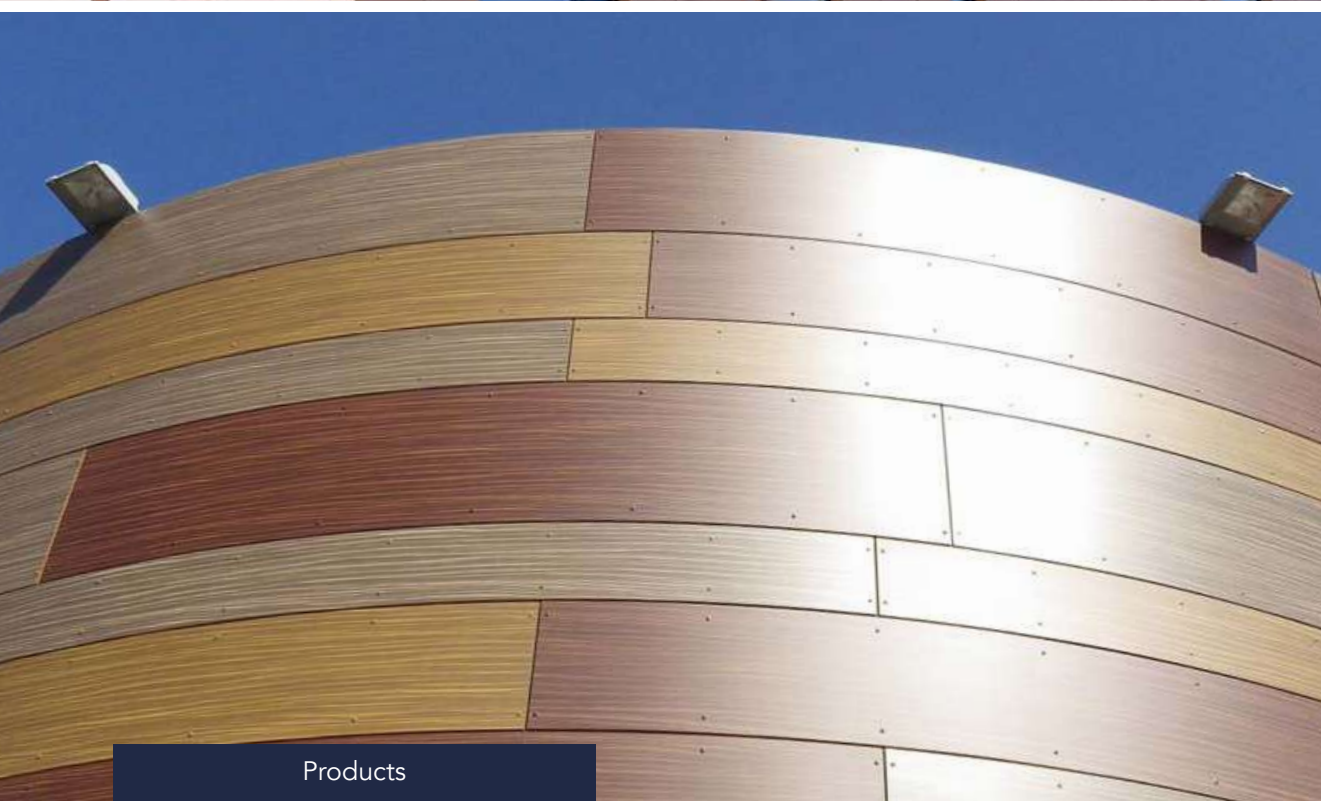





Facades with a natural look. In perfect harmony with the environment.

Good architecture seeks and always finds dialogue with its environment. Rockpanel Nature facades can be taken literally. Take advantage of the unlimited shapes and colours of nature. And turn your building into an organic, natural part of its surroundings.



Rockpanel Natural

Uncoated Rockpanel Natural is a pure beauty. The appearance is determined by the climate.



Rockpanel Woods

Give your building an exceptional wood look – durable and fire safe with Rockpanel Woods.



Rockpanel Stones

Use the authentic power of stone as a theme for impressive facades – with Rockpanel Stones.

Nature facades

Play around with natural surfaces and designs

Design your facade in the beauty of nature

- Natural look
- Sustainable material
- Recyclable
- Natural weathering effect (Natural)
- High level of fire safety: A2-s1,d0 optional (only for Woods and Stones)
- Lightweight stone look (Stones)
- Low maintenance





**Rockpanel Natural.
In dialogue with the elements.**

The true beauty of a facade is sometimes quite puristic. Be brave – let the sun, wind and rain play their part. Without applying paint or surface sealer, Rockpanel Natural allows the elements to take an active role in your facade. Your building fits organically into its surroundings, in an interactive way from day one.

Rockpanel Natural



Typical natural colour upon delivery

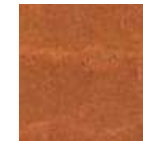

Indicative natural colour after ± 6 weeks (may vary)

Assortment

Product Line	Board Composition	Thickness	Standard dimensions
Rockpanel Natural	Durable	10 mm	1200/1250 x 2500/3050 mm

Key product properties

	Rockpanel Natural	Unit	Test/classification method
Fire			
Fire classification	B-s2,d0	Euroclass	EN 13501-1

The Euroclass-classification of all Rockpanel products is based on testing with non-combustible mineral wool insulation. For the field of application covered by the classification please see the relevant Declaration of Performance. For high-rise buildings and high-risk buildings Rockpanel recommends the application of non-combustible (Euroclass A1 or A2) cladding and insulation.

Physical properties			
Thickness	10	mm	EN 325
Weight	10.5	kg/m ²	
Density, nominal	1050	kg/m ³	EN 323
Thermal conductivity	0.37	W/m·K	EN 10456
Coefficient of thermal expansion	10.5	x10 ⁻³ mm/m·K	EN 438:2 clause 17
Coefficient of moisture expansion (after 4 days)	0.302	mm/m	EN 438:2 clause 17
Mechanical properties			
Bending strength, length and width (f ₀₅)	≥ 27	N/mm ²	EN 310 / EN 1058
Modulus of elasticity m(E)	4015	N/mm ²	EN 310

Fixing distances

Maximum Fixing distances (mm)	Rockpanel Durable 10 mm	
	b max.	a max.
Nail	600	400
Screw	600	600
Rivet	600	600

The appearance of these durable boards will change under the influence of the local climate.

As with other natural materials such as wood, concrete and steel, light from the sun ensures natural weathering and colouring over time.

Natural

Durable 10 mm
Rockpanel in its purest
form



- Natural base material
- Naturally ageing
- Dimensionally stable
- Does not delaminate or rot



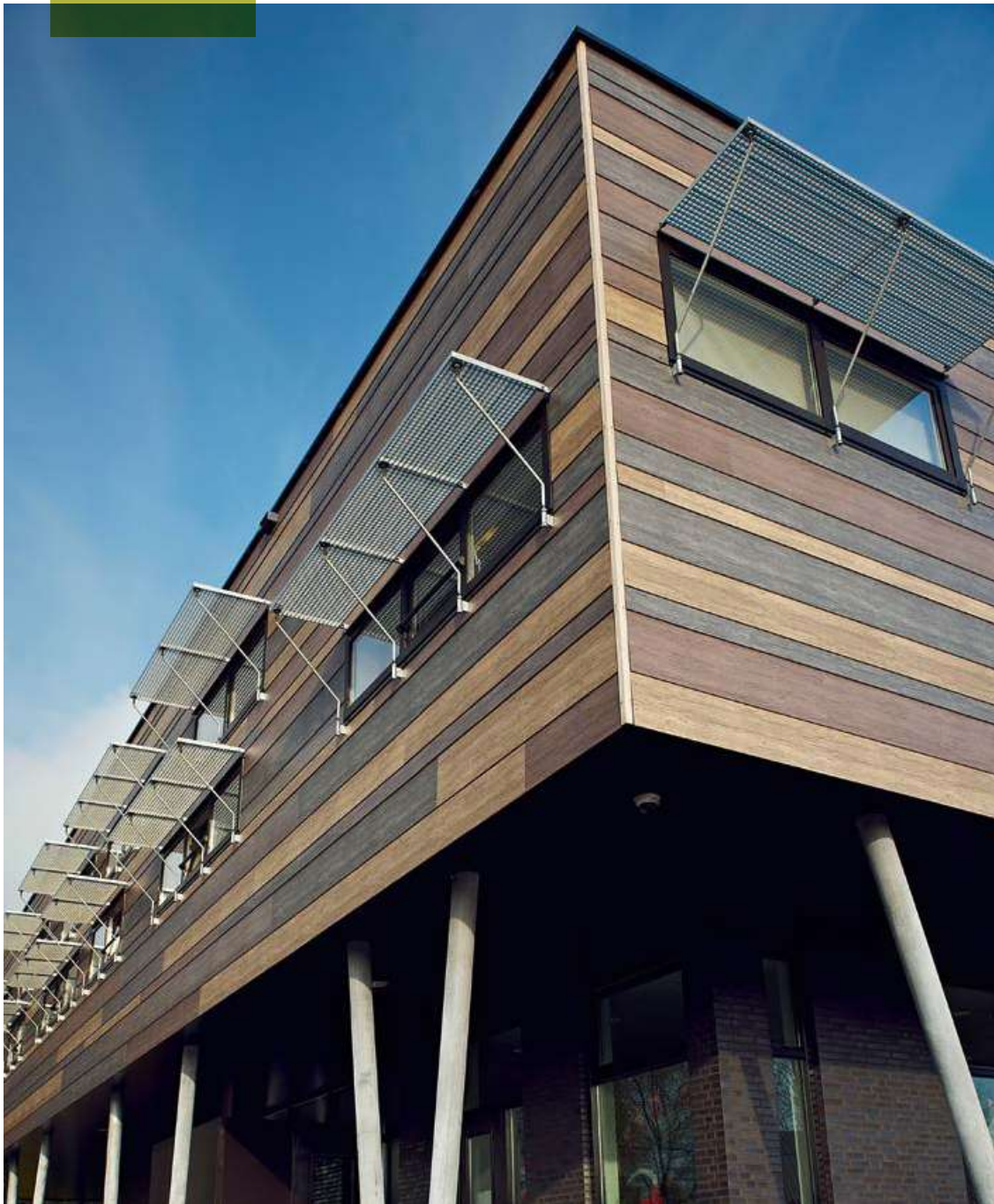

Rockpanel Woods.
Alive like wood. Sturdy as stone.

Amaze everyone and make the users of your building feel good. With facades that radiate the warm, organic glow of wood. Build with the freedom and stability your modern architecture requires. Rockpanel Woods gives your building a natural wood look. And at the same time the durability, stability and fire protection of a stone facade.

Rockpanel Woods



Assortment

Product Line	Board Composition	Thickness	Standard dimensions
Rockpanel Woods	Durable	8 mm	1200/1250 x 2500/3050 mm
	A2	9 mm	

Key product properties

Rockpanel Woods	Durable	A2	Unit	Test/classification method
Optical properties				
Colour stability (5000 h)	ProtectPlus: 4 or better	ProtectPlus: 4 or better	Class on greyscale	ISO 105 A02
Fire				
Fire classification	B-s2,d0	A2-s1,d0	Euroclass	EN 13501-1

The Euroclass-classification of all Rockpanel products is based on testing with non-combustible mineral wool insulation. For the field of application covered by the classification please see the relevant Declaration of Performance. For high-rise buildings and high-risk buildings Rockpanel recommends the application of non-combustible (Euroclass A1 or A2) cladding and insulation.

Physical properties				
Weight	8 mm: 8.4	9 mm: 11.25	kg/m ²	
Density, nominal	1050	1250	kg/m ³	EN 323
Thermal conductivity	0.37	0.55	W/m·K	EN 10456
Water vapour permeability S _d (at 23 °C and 85 % RF) ProtectPlus	< 3.5	N/A	m	EN 12572
Coefficient of thermal expansion	10.5	9.7	x10 ⁻³ mm/m·K	EN 438:2 clause 17
Coefficient of moisture expansion (after 4 days)	0.302	0.206	mm/m	EN 438:2 clause 17
Mechanical properties				
Bending strength, length and width (f ₀₅)	≥ 27	≥ 25.5	N/mm ²	EN 310 / EN 1058
Modulus of elasticity m(E)	4015	4740	N/mm ²	EN 310

Fixing distances

Maximum Fixing distances (mm)	Durable 8 mm		A2 9 mm	
	b max.	a max.	b max.	a max.
Nail	600	400	N/A	N/A
Screw	600	600	N/A	N/A
Rivet	600	600	600	600
Bonding	600	uninterrupted glue line	N/A	N/A

Woods

Durable 8 mm

A2, 9 mm

A warm and authentic look

ProtectPlus



- Authentic wood look
- No visual repetition
- Wood that does not burn
- Low maintenance
- Colourfast





**Rockpanel Stones.
Stones reach the sky.**

Visionary architecture is characterised by a courageous crossing of borders. Overcome limits – even those in nature. Design facades with the powerful look of stone. Build with its strength. But remain flexible in terms of shape and dimension. Challenge gravity – with the ease of Rockpanel Stones.

Rockpanel Stones



Assortment

Product Line	Board Composition	Thickness	Standard dimensions
Rockpanel Stones	Durable	8 mm	1200/1250 x 2500/3050 mm
	A2	9 mm	

Key product properties

Rockpanel Stones	Durable	A2	Unit	Test/classification method
Optical properties				
Colour stability (5000 h)	ProtectPlus: 4 or better	ProtectPlus: 4 or better	Class on greyscale	ISO 105 A02
Fire				
Fire classification	B-s2,d0	A2-s1,d0	Euroclass	EN 13501-1

The Euroclass-classification of all Rockpanel products is based on testing with non-combustible mineral wool insulation. For the field of application covered by the classification please see the relevant Declaration of Performance. For high-rise buildings and high-risk buildings Rockpanel recommends the application of non-combustible (Euroclass A1 or A2) cladding and insulation.

Physical properties				
Weight	8 mm: 8.4	9 mm: 11.25	kg/m ²	
Density, nominal	1050	1250	kg/m ³	EN 323
Thermal conductivity	0.37	0.55	W/m·K	EN 10456
Water vapour permeability S _d (at 23 °C and 85 % RH) ProtectPlus	< 3.5	N/A	m	EN 12572
Coefficient of thermal expansion	10.5	9.7	x10 ⁻³ mm/m·K	EN 438:2 clause 17
Coefficient of moisture expansion (after 4 days)	0.302	0.206	mm/m	EN 438:2 clause 17
Mechanical properties				
Bending strength, length and width (f ₀₅)	≥ 27	≥ 25.5	N/mm ²	EN 310 / EN 1058
Modulus of elasticity m(E)	4015	4740	N/mm ²	EN 310

Fixing distances

Maximum Fixing distances (mm)	Durable 8 mm		A2 9 mm	
	b max.	a max.	b max.	a max.
Nail	600	400	N/A	N/A
Screw	600	600	N/A	N/A
Rivet	600	600	600	600
Bonding	600	uninterrupted glue line	N/A	N/A

Stones

Durable 8 mm

A2, 9 mm

Stone as light as wood

ProtectPlus



- Light-weight
- Self-cleaning
- Low maintenance
- Easy to bend and curve





Design facades

Explore shapes and
colours freely

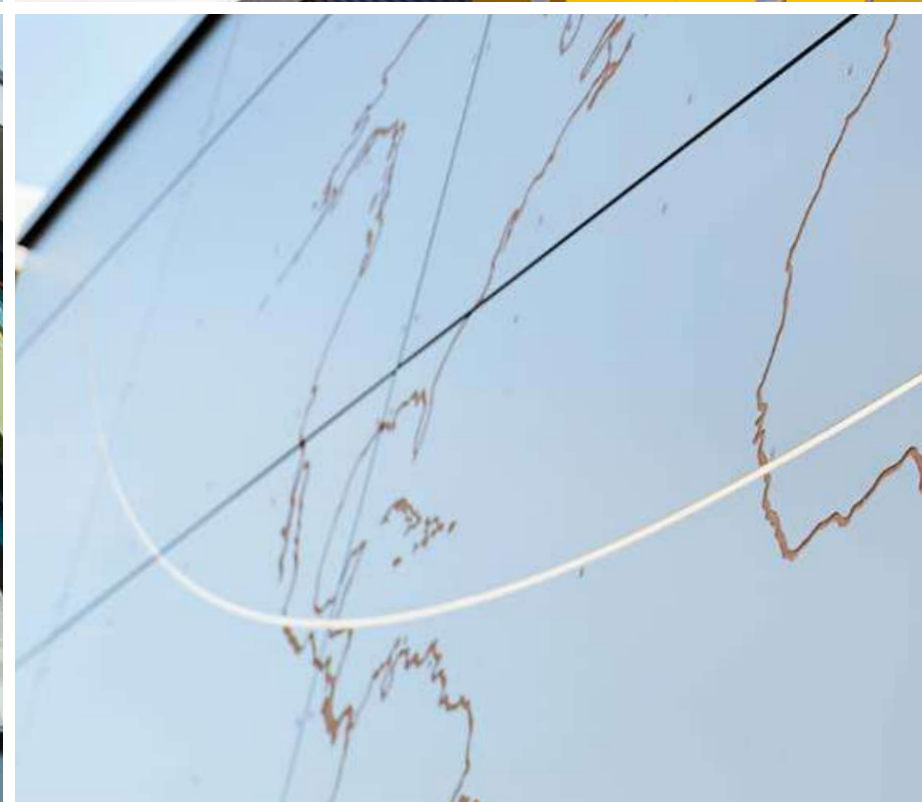
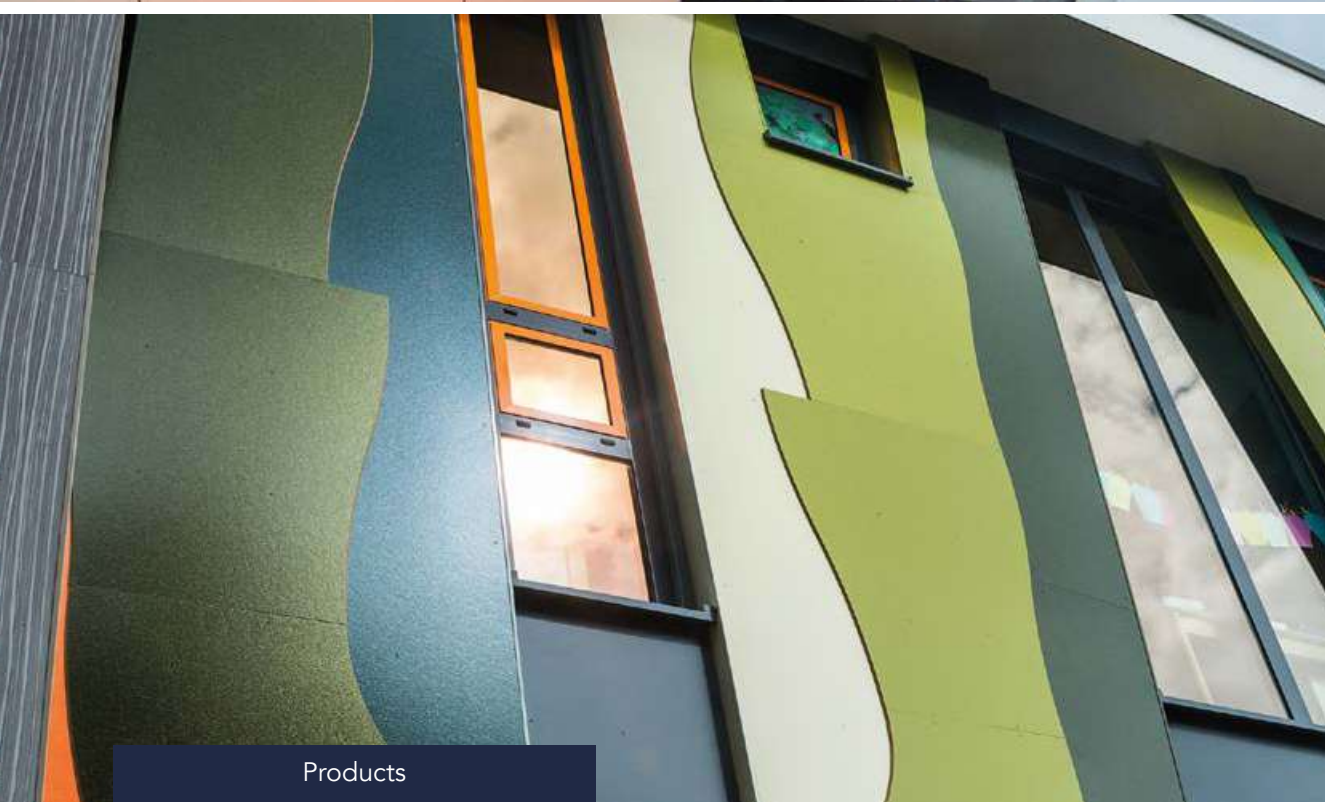





Rockpanel Colours

Create colourful statements or go for more subtle beauty. Colour becomes a design element with Rockpanel Colours.

Expressive in every way. And in all colours.

Design with plenty of courage, ideas and colour.
Give your building a striking facade design that makes it stand out.
You have complete freedom – use the power of your imagination.



Rockpanel Metals

For the ultimate industrial design –
Rockpanel Metals shines in every
way.



Rockpanel Chameleon

Challenge how you view things –
from every perspective, with
Rockpanel Chameleon.

Design facades

Explore shapes and
colours freely.

Design your facade full of expression

- Wide variety of RAL and NCS colours
- Custom colours on request
- Expressive designs
- 3D shapes (bending and curving)
- Invisible fixing available
- High level of fire safety: A2-s1,d0 optional

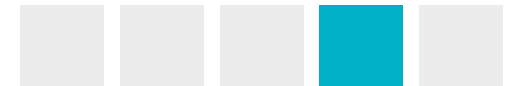



**Rockpanel Colours.
Fascinating colour range.**

Let your facade blend into the environment. Or emphasise the features in an urban setting. Enjoy complete freedom in the design of your building – in almost any colour of your choice. Our Rockpanel Colours assortment consists of Standard and Special colours. In addition to our standard and special RAL/NCS colours, you can choose almost any Custom RAL/NCS colour if you want to create something even more unique. Visit our website for the minimum order quantity and delivery times of Rockpanel Colours Standard, Special and Custom. For a colourfast decorative statement, Rockpanel Colours is the perfect choice.

Assortment

Product Line	Board Composition	Thickness	Standard dimensions
Rockpanel Colours	Durable	6 mm, 8 mm	1200/1250 x 2500/3050 mm
	A2	9 mm	

Key product properties

Rockpanel Colours	Durable	A2	Unit	Test/classification method
Optical properties				
Colour stability (5000 h)	ProtectPlus: 4 or better Colours: 3-4 or better	ProtectPlus: 4 or better Colours: 3-4 or better	Grey scale	ISO 105 A02
Fire				
Fire classification	B-s2,d0	A2-s1,d0	Euroclass	EN 13501-1
The Euroclass-classification of all Rockpanel products is based on testing with non-combustible mineral wool insulation. For the field of application covered by the classification please see the relevant Declaration of Performance. For high-rise buildings and high-risk buildings Rockpanel recommends the application of non-combustible (Euroclass A1 or A2) cladding and insulation.				
Physical properties				
Weight	6 mm: 6.3 8 mm: 8.4	9 mm: 11.25	kg/m ²	
Density, nominal	1050	1250	kg/m ³	EN 323
Thermal conductivity	0.37	0.55	W/m·K	EN 10456
Water vapour permeability S _d (at 23 °C and 85 % RH) Colours	< 1.80	N/A	m	EN 12572
Water vapour permeability S _d (at 23 °C and 85 % RH) ProtectPlus	< 3.5	N/A	m	EN 12572
Coefficient of thermal expansion	10.5	9.7	x10 ⁻³ mm/m·K	EN 438:2 clause 17
Coefficient of moisture expansion (after 4 days)	0.302	0.206	mm/m	EN 438:2 clause 17
Mechanical properties				
Bending strength, length and width (f ₀₅)	≥ 27	≥ 25.5	N/mm ²	EN 310 / EN 1058
Modulus of elasticity m(E)	4015	4740	N/mm ²	EN 310

Fixing distances

Maximum Fixing distances (mm)	Durable 6 mm		Durable 8 mm		A2 9 mm	
	b max.	a max.	b max.	a max.	b max.	a max.
Nail	400	300	600	400	N/A	N/A
Screw	400	300	600	600	N/A	N/A
Rivet	N/A	N/A	600	600	600	600
Bonding	N/A	N/A	600	uninterrupted glue line	N/A	N/A

Colours

Durable 6 & 8 mm
A2, 9 mm
ProtectPlus
(option, excl. 6 mm)



- Wide range of standard colours
- Custom colours
- Easy to clean
- RAL and NCS as reference

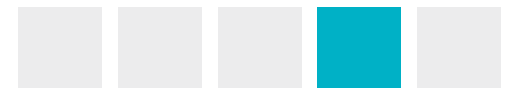



RAL 7001



RAL 7012



RAL 7031



RAL 7016



RAL 7021



RAL 9011

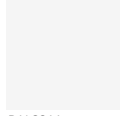

RAL 9016



RAL 7024



RAL 280 20 05

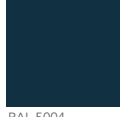

RAL 5004



RAL 7004



RAL 000 50 00



RAL 7037

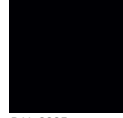

RAL 9005

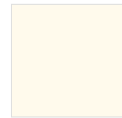

RAL 9010

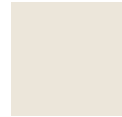

RAL 080 80 05



RAL 060 70 05



RAL 7036



RAL 040 50 05



RAL 060 50 05



RAL 080 30 05



RAL 7022

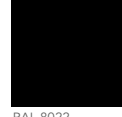

RAL 8022



NCS S 0520-R10B



RAL 3015



RAL 010 30 44



RAL 350 40 35



NCS S 4030-R50B



RAL 4004



RAL 4007



RAL 350 20 10

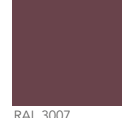

RAL 3007



NCS S 0570-Y90R



RAL 030 50 50



RAL 3028



RAL 3001



RAL 3004

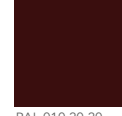

RAL 010 20 20



RAL 020 20 05



NCS S 1080-Y50R



RAL 2010



RAL 2012



RAL 040 50 70



RAL 3016



RAL 040 40 50



RAL 3009



RAL 060 50 70



RAL 8023



RAL 050 40 40



RAL 8024



RAL 060 30 20



RAL 8028



RAL 050 30 10



RAL 060 70 20



RAL 060 50 30



RAL 8001



RAL 060 60 50



RAL 7006



RAL 070 70 60



RAL 070 60 75



RAL 100 90 20



RAL 100 90 50



NCS S 2050-Y



RAL 1012



RAL 1032

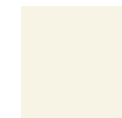

RAL 9001



RAL 1013



RAL 1015



RAL 095 70 10



RAL 090 80 20



RAL 1002



NCS S 3030-Y10R



NCS S 5020-Y10R



RAL 075 40 30



RAL 9002



RAL 100 80 05



RAL 7030



RAL 7039



RAL 080 40 05



RAL 080 30 10



RAL 6022



RAL 9003



RAL 7035



RAL 7038



RAL 7010



RAL 7033



RAL 7009

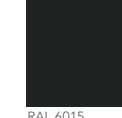

RAL 6015



Colours

Durable 6 & 8 mm
A2, 9 mm (option)
ProtectPlus
(option, excl. 6 mm)

A complete colour palette of our Rockpanel Colours assortment. Next to this assortment, almost any other RAL / NCS colour is possible.

The colours shown give a good impression of the actual colour. However, it is not possible in print to accurately represent the colours. If you would like more samples, please contact us at www.rockpanel.co.uk

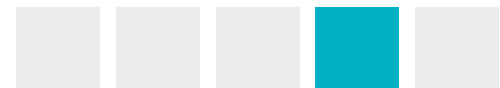



Rockpanel Metals.
Sleek surfaces with an industrial look.

Modern architecture is often characterised by an industrial design look. Give your high-quality facades an elegant finish. Rockpanel Metals creates amazing effects on facades because of the sheen from the light striking it – even with timelessly modern residential buildings.

Our **Elemental Metals** line consists of the main precious metals such as gold, silver and platinum. It also includes other well-known metals such as aluminium, steel and copper. Our **Advanced Metals** line includes designs which will give your facade a distinctive look. Thanks to our advanced technology, they have an exceptional worn finish that lasts for decades.

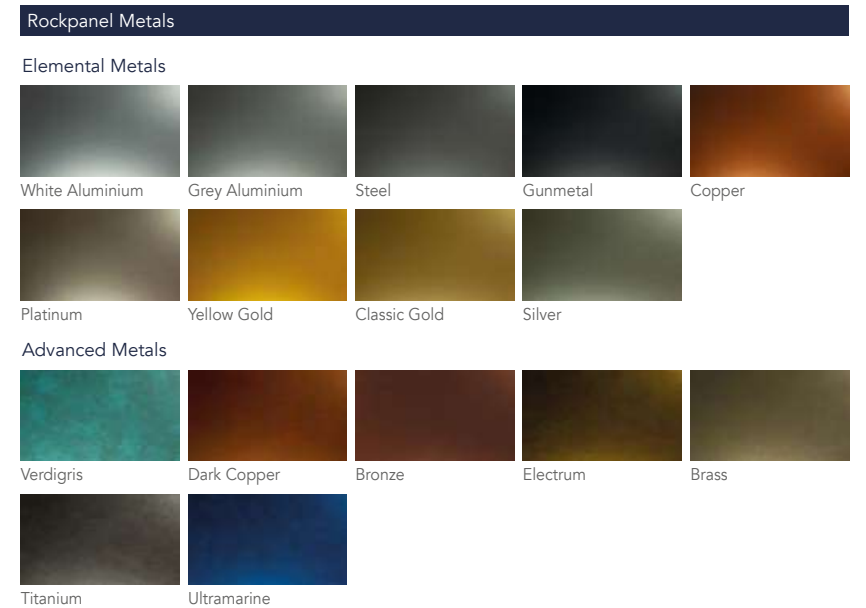

Assortment

Product Line	Board Composition	Thickness	Standard dimensions
Rockpanel Metals	Durable	8 mm	1200/1250 x 2500/3050 mm
	A2	9 mm	

Key product properties

Rockpanel Metals	Durable	A2 (option)	Unit	Test/classification method
Optical properties				
Colour stability (5000 h)	ProtectPlus: 4 or better	ProtectPlus: 4 or better	Class on greyscale	ISO 105 A02
Fire				
Fire classification	B-s2,d0	A2-s1,d0	Euroclass	EN 13501-1

The Euroclass-classification of all Rockpanel products is based on testing with non-combustible mineral wool insulation. For the field of application covered by the classification please see the relevant Declaration of Performance. For high-rise buildings and high-risk buildings Rockpanel recommends the application of non-combustible (Euroclass A1 or A2) cladding and insulation.

Physical properties				
Weight	8 mm: 8.4	9 mm: 11.25	kg/m ²	
Density, nominal	1050	1250	kg/m ³	EN 323
Thermal conductivity	0.37	0.55	W/m·K	EN 10456
Water vapour permeability S _d (at 23 °C and 85 % RH) ProtectPlus	< 3.5	N/A	m	EN 12572
Coefficient of thermal expansion	10.5	9.7	x10 ⁻³ mm/m·K	EN 438:2 clause 17
Coefficient of moisture expansion (after 4 days)	0.302	0.206	mm/m	EN 438:2 clause 17
Mechanical properties				
Bending strength, length and width (f ₀₅)	≥ 27	≥ 25.5	N/mm ²	EN 310 / EN 1058
Modulus of elasticity m(E)	4015	4740	N/mm ²	EN 310

Fixing distances

Maximum Fixing distances (mm)	Durable 8 mm		A2 9 mm	
	b max.	a max.	b max.	a max.
Nail	600	400	N/A	N/A
Screw	600	600	N/A	N/A
Rivet	600	600	600	600
Bonding	600	uninterrupted glue line	N/A	N/A

Metals

Durable 8 mm

A2, 9 mm

ProtectPlus

A sleek industrial look



- Contemporary metallic design
- Self-cleaning
- Non-directional

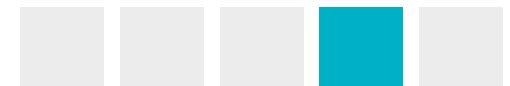



Rockpanel Chameleon.
Fascinatingly different from every angle.

Transform your building into an eye-catching feature that is constantly changing, but always striking and inspiring. Just change your position around the facade. The colour will never be the same no matter how long you look at the building. Depending on the angle from which it is viewed and the effect of the sunlight, the surface of the Rockpanel Chameleon facade changes. The secret of this vibrant colour is a special crystal effect layer. The effect remains permanently protected for many years.



Assortment

Product Line	Board Composition	Thickness	Standard dimensions
Rockpanel Chameleon	Durable	8 mm	1200 x 2500/3050 mm
	A2	9 mm	

Key product properties

Rockpanel Chameleon	Durable	A2	Unit	Test/classification method
Optical properties				
Colour stability (5000 h)	ProtectPlus: 4 or better	ProtectPlus: 4 or better	Class on greyscale	ISO 105 A02
Fire				
Fire classification	B-s2,d0	A2-s1,d0	Euroclass	EN 13501-1

The Euroclass-classification of all Rockpanel products is based on testing with non-combustible mineral wool insulation. For the field of application covered by the classification please see the relevant Declaration of Performance. For high-rise buildings and high-risk buildings Rockpanel recommends the application of non-combustible (Euroclass A1 or A2) cladding and insulation.

Physical properties				
Weight	8 mm: 8.4	9 mm: 11.25	kg/m ²	
Density, nominal	1050	1250	kg/m ³	EN 323
Thermal conductivity	0.37	0.55	W/m·K	EN 10456
Water vapour permeability S _d (at 23 °C and 85 % RF) ProtectPlus	< 3.5	N/A	m	EN 12572
Coefficient of thermal expansion	10.5	9.7	x10 ⁻³ mm/m·K	EN 438:2 clause 17
Coefficient of moisture expansion (after 4 days)	0.302	0.206	mm/m	EN 438:2 clause 17
Mechanical properties				
Bending strength, length and width (f ₀₅)	≥ 27	≥ 25.5	N/mm ²	EN 310 / EN 1058
Modulus of elasticity m(E)	4015	4740	N/mm ²	EN 310

Fixing distances

Maximum Fixing distances (mm)	Durable 8 mm		A2 9 mm	
	b max.	a max.	b max.	a max.
Nail	600	400	N/A	N/A
Screw	600	600	N/A	N/A
Rivet	600	600	600	600
Bonding	600	uninterrupted glue line	N/A	N/A

Chameleon

Durable 8 mm

A2, 9 mm

ProtectPlus

For a truly eye-catching facade



- Chameleon effect
- Non-directional
- Self-cleaning

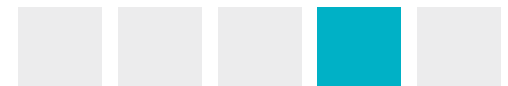

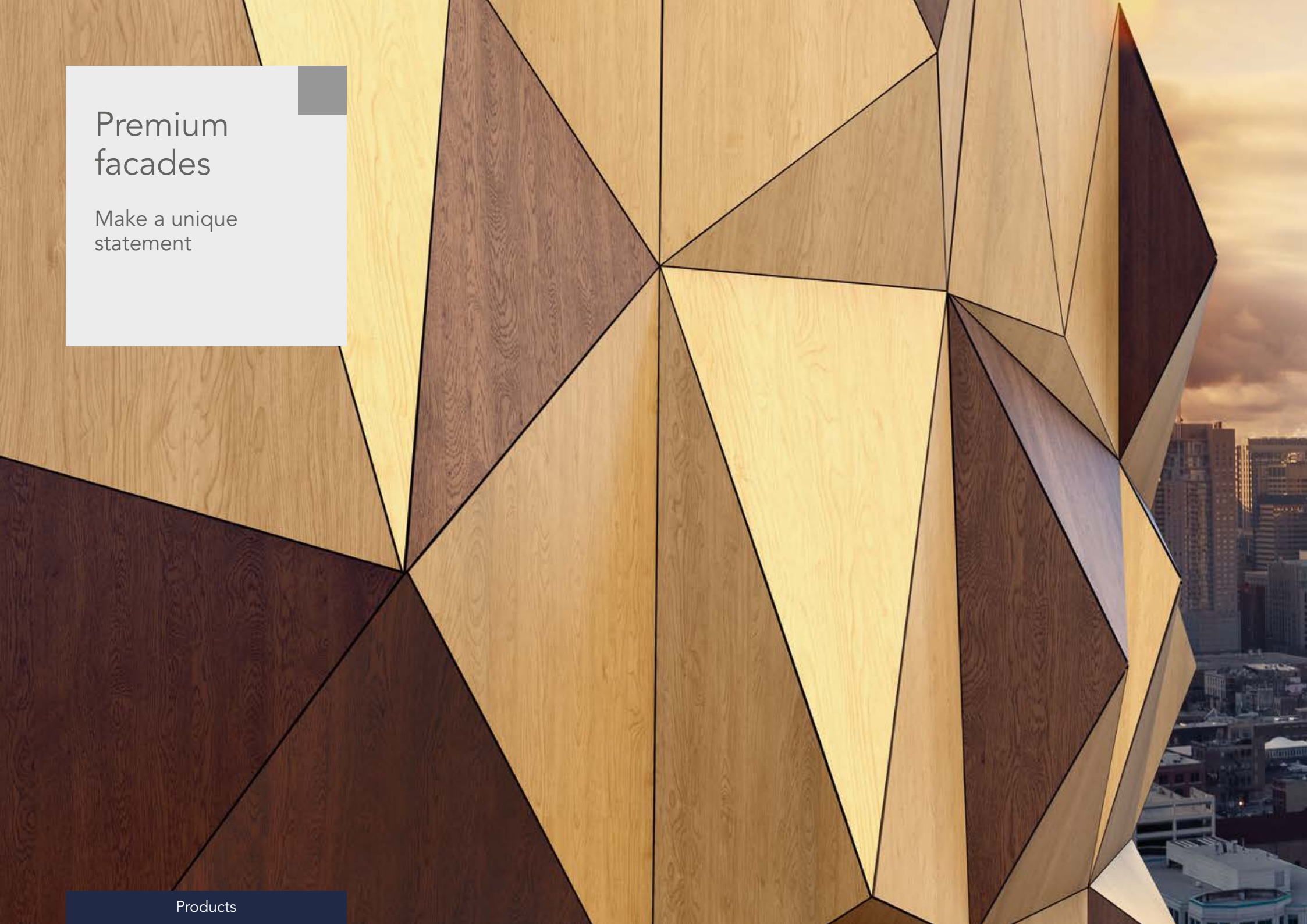

Premium facades

Make a unique
statement





Impressive facades. Unique and innovative.

If you don't want to compromise on the design and detail of your project, Rockpanel Premium facades are the right choice for you. Find the right facade solutions – without limits.

Rockpanel Premium. Customised facade solutions.

Rockpanel Premium combines all the advantages of Rockpanel facade panels and also offers a number of choices outside of the norm. Because your brilliant idea isn't within the norm either.



Custom designs

Combine all of our colours, designs and finishes, anyway you want it. For example, mix the patterns of Rockpanel Woods or Stones with the effects of Rockpanel Chameleon or Metals.



ProtectPlus comes standard

Protect valuable facades in all circumstances – highly effective against dirt and graffiti.



Matt, semi-gloss, high-gloss

When realizing your project, you want every detail to be just right. That's why we offer three different gloss grades.

Plan without limits

Do you think beyond standard solutions? Then Rockpanel Premium is right for you – with custom colours and designs, and customised formats and dimensions.



Concealed fixing

No visible rivets or screws – just your flawless facade design. Our concealed fixing system ensures a quick and easy installation and guarantees absolute stability.

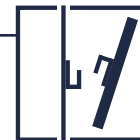

Fire safe

With Rockpanel Premium, you will always meet high fire protection requirements, since the facade panels are classified as A2-s1,d0 according to EN 13501-1.



Premium facades

Premium A2,
11 mm
ProtectPlus
Custom designs



- Customised designs
- Customised panel sizes
- Euroclass A2-s1,d0 as standard
- Choice of gloss level
- Self-cleaning ProtectPlus layer as standard

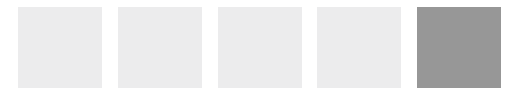

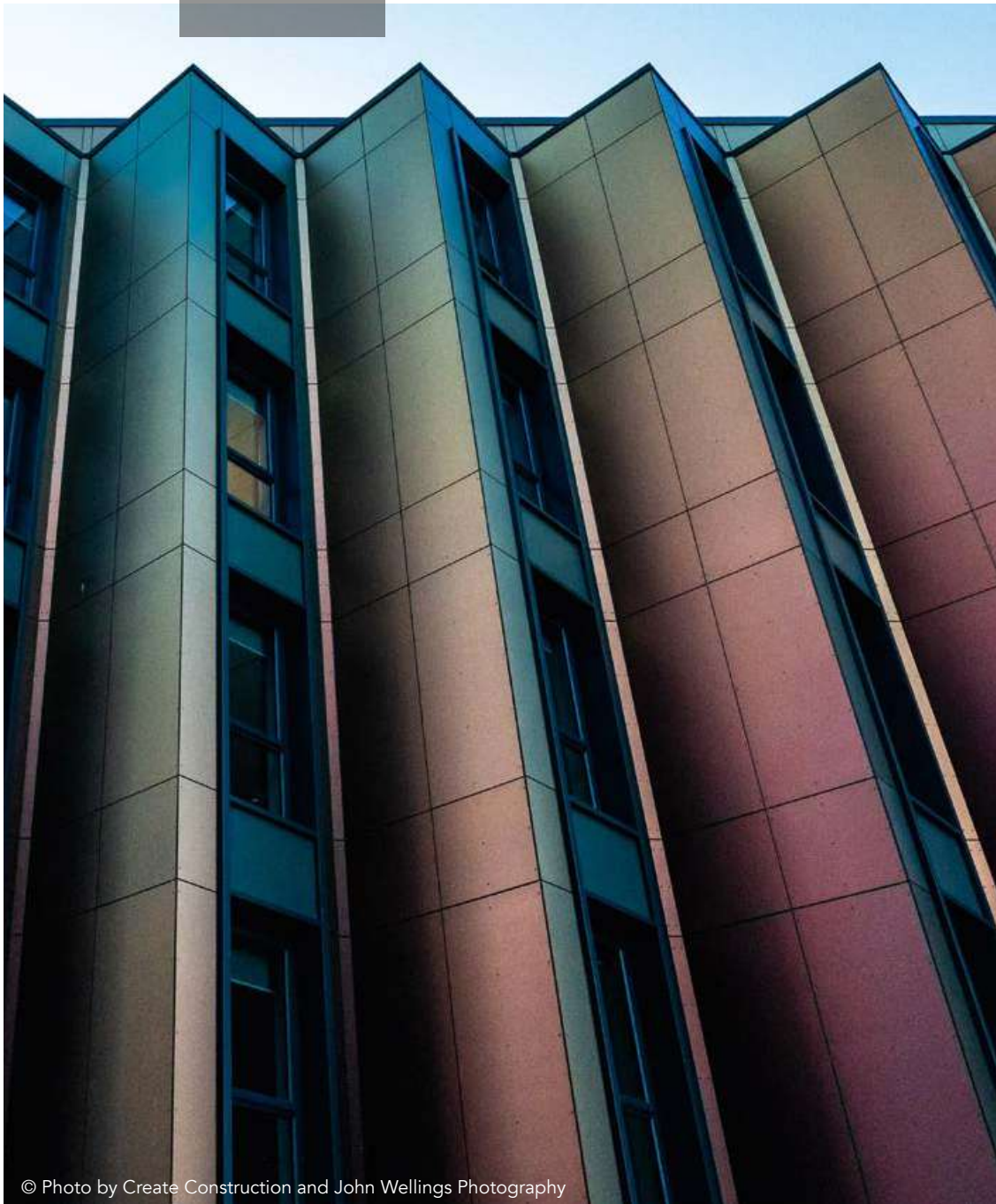

© Photo by Create Construction and John Wellings Photography

**Rockpanel Premium.
The expression of success.**

Take the freedom to transform buildings into representative symbols that visually express the success of your business. The best materials, open-ended design solutions as well as customised formats and dimensions give your building project an absolute premium look. Naturally, they always meet the particularly high requirements for fire protection: Euroclass A2-s1,d0.

Assortment

Product Line	Board Composition	Thickness	Standard dimensions
Rockpanel Premium	A2	11 mm	1200/1250 x 1700-3050 mm

Key product properties

Rockpanel Premium	Premium A2	Unit	Test/classification method
Optical properties			
Colour stability ProtectPlus (5000 h)	4 or better	Class on greyscale	ISO 105 A02
Fire			
Fire classification	A2-s1,d0	Euroclass	EN 13501-1

The Euroclass-classification of all Rockpanel products is based on testing with non-combustible mineral wool insulation. For the field of application covered by the classification please see the relevant Declaration of Performance. For high-rise buildings and high-risk buildings Rockpanel recommends the application of non-combustible (Euroclass A1 or A2) cladding and insulation.

Physical properties			
Thickness	11	mm	EN 325
Weight	13.75	kg/m ²	
Density, nominal	1250	kg/m ³	EN 323
Thermal conductivity	0.55	W/m·K	EN 10456
Water vapour permeability S _d (at 23 °C and 85 % RF) ProtectPlus	N/A	m	EN 12572
Coefficient of thermal expansion	9.7	x10 ⁻³ mm/m·K	EN 438:2 clause 17
Coefficient of moisture expansion (after 4 days)	0.206	mm/m	EN 438:2 clause 17
Mechanical properties			
Bending strength, length and width (f ₀₅)	≥ 25.5	N/mm ²	EN 310 / EN 1058
Modulus of elasticity m(E)	≥ 4740	N/mm ²	EN 310

Fixing distances

Maximum Fixing distances (mm)	Rockpanel Premium A2, 11 mm	
	b max.	a max.
Rivet	750	750
Concealed (Blind fasteners TU-S)	750	600

Premium

Custom colours and designs
Euroclass A2-s1, d0
and ProtectPlus layer
as standard

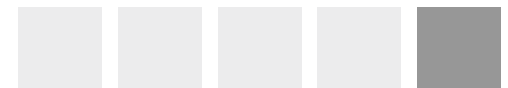





Accessories

Accessories

Mechanical fixing

Fixing method	Suitable for Rockpanel	Colour
Ring Shank nails 27 mm	Lines ² 10 mm	Stainless Steel
Ring Shank nails 32 mm	Natural / Chameleon / Ply	Stainless Steel
	Uni	Standard Colours
	Colours	Standard, Special and Custom Colours
HP Nail 35 mm	Woods / Stones / Metals	Woods / Stones / Metals
	Natural / Chameleon / Ply	Stainless Steel
	Uni	Standard Colours
Screws 35 mm	Colours	Standard, Special and Custom Colours
	Woods / Stones / Metals	Woods / Stones / Metals
	Natural / Chameleon / Ply	Stainless Steel
Screws 35 mm	Uni	Standard Colours
	Colours	Standard, Special and Custom Colours
	Woods / Stones / Metals	Woods / Stones / Metals

Adhesive system

	Quantity	Indicative usage per 100 m ²
Rockpanel Tack-S (certified)	290 ml	50 cartridges
Primer MSP Transparent for the back of the boards	500 ml	6 cans
Prep M Primer for aluminium sub-construction	500 ml	2 cans
Foam tape (double sided)	25 m ¹	12 rolls
Cleaner liquid 1	1 ltr	1 can

Concealed fixing

Combined with our Rockpanel Premium A2 board in thickness 11 mm, you can use the concealed fixing system.

Concealed fixing	Quantity
Blind fastener TU-S-6x 11-A4*	500 pcs per box
Blind fastener TU-S-6x 13-A4**	500 pcs per box
HSS-Drill bit 6,0 x 43,5	1 piece
Depth locator for drill bit universal	1 piece

* for use with a 3 mm panel clip
 ** for use with a 5 mm panel clip

Other accessories





















Article	Width	Quantity
EPDM Foamtape (adhesive)	36 mm	50 m ¹
EPDM Foamtape (adhesive)	60 mm	50 m ¹
EPDM Foamtape (adhesive)	80 mm	50 m ¹
EPDM Foamtape (adhesive)	100 mm	25 m ¹
EPDM Foamtape (adhesive)	130 mm	25 m ¹
Rockpanel Graffiti Cleaner		780 ml
Rockpanel Edge paint (only Rockpanel Colours)*		780 ml

* Special and Custom Colours are only available in combination with Rockpanel Boards. For painting the edges of Woods, Stones, Metals and Chameleon, we advise RAL 9005 (black).

Profiles

















High quality aluminium External Corner profiles, Edge profiles, Joint profiles and Starter profiles can be supplied in almost every RAL/NCS colour. Please contact Rockpanel for details of your local supplier.

Aluminium profiles – Rockpanel boards

	Standard length 3055 mm		Colours	Profile size*
	Profile A		Blanc anodised Standard Special/Custom	6, 8, 10 mm
	Profile B		Blanc anodised RAL 9005 / RAL 9010	One size fits all
	Profile C		Blanc anodised Standard Special/Custom	6, 8, 10 mm
	Profile D		Blanc anodised Standard Special/Custom	6, 8, 10 mm
	Profile E		Blanc anodised Standard Special/Custom	6, 8, 10 mm
	Profile F		Blanc anodised Standard Special/Custom	6, 8, 10 mm
	Profile G		Blanc anodised Standard Special/Custom	8 mm
	Profile H		Blanc anodised Standard Special/Custom	6, 8, 10 mm
	Profile I		Blanc anodised	One size fits all
	Profile J		Blanc anodised	One size fits all

* Boards in 9 mm thickness (A2), require a 10 mm profile.

Aluminium profiles – Rockpanel Lines²

	Standard length 3055 mm		Colours	Profile size
	Profile C		Blanc anodised Standard Special/Custom	10 mm
	Profile D		Blanc anodised Standard Special/Custom	10 mm
	Profile E		Blanc anodised Standard Special/Custom	10 mm
	Profile F		Blanc anodised Standard Special/Custom	10 mm
	Profile H		Blanc anodised Standard Special/Custom	10 mm
	Profile I		Blanc anodised	10 mm
	Profile J		Blanc anodised	10 mm
	Profile K*		Blanc anodised	10 mm

Please ensure with the supplier the suitability of their fixings to meet our technical requirements. Working with accessories from other manufacturers should be carried out according to their recommendations, their supervision and their warranty conditions.

* For easy connection at ground level, a Rockpanel starting profile (type K) can be used for placement of the lowest section of Rockpanel Lines².





Technical information





Technical information

Product properties

Overview product properties	95
Design advantages	96 - 97
Installation advantages	98 - 99

Working with Rockpanel

Packaging, transport and storage	100
Get started with Rockpanel boards	101

Sub-construction

Ventilated facade	102 - 103
Alternative applications	105
Sub-construction materials	106 - 107

Fixing

Fixing to timber sub-construction	108 - 110
Fixing to aluminium sub-construction	111
Fixing to steel sub-construction	112
Tension-free fixing	114 - 115
Fixing guidelines	116 - 133

Board joints, corner solutions and bending

Board joints	134
Corner solutions	134
Bending and curving	135
Guidelines seamless installation	135

Details

Facade	138 - 152
Roofline	153 - 154
Detailing	155



Overview product properties

Properties		Value	Unit	Standard
Mechanical				
Modulus of elasticity	A2	≥ 4740	N/mm ²	EN 310
Characteristic bending strength f_{05}	A2	≥ 25.5	N/mm ²	EN 310 & EN 1058
Modulus of elasticity	Durable	4015	N/mm ²	EN 310
Characteristic bending strength f_{05}	Durable	≥ 27	N/mm ²	EN 310 & EN 1058
Modulus of elasticity	Uni	3567	N/mm ²	EN 310
Characteristic bending strength f_{05}	Uni	≥ 24	N/mm ²	EN 310 & EN 1058
Modulus of elasticity	Ply	3065	N/mm ²	EN 310
Characteristic bending strength f_{05}	Ply	≥ 15	N/mm ²	EN 310 & EN 1058
Optical				
Colour stability (5000 hours; Xenon test)	Rockpanel Colours / Lines ²	3-4 or better	Greyscales	EN 20105-A02
	Rockpanel Colours (PP) Woods / Stones / Metals / Chameleon / Premium	4 or better	Greyscales	EN 20105-A02
	Rockpanel Uni	3 or better		
Fire				
Fire classification	Euroclass B-s2,d0 (Durable/Ply/Uni)* Euroclass A2-s1,d0 (A2)*			EN 13501-1
Physical				
Nominal density	A2	1250	kg/m ³	EN 323
	Durable	1050	kg/m ³	
	Uni	1050	kg/m ³	
	Ply	1000	kg/m ³	
Nominal mass of surface	A2	9 mm: 11.25	kg/m ²	
	Premium A2	11 mm: 13.75	kg/m ²	
	Durable	6 mm: 6.3	kg/m ²	
	Durable	8 mm: 8.4	kg/m ²	
	Uni	6 mm: 6.3	kg/m ²	
	Ply	8 mm: 8	kg/m ²	
Vapour permeability S_d at 23°C and 85% RH	Rockpanel Colours	1.8	m	EN-ISO 12572
	Rockpanel with ProtectPlus **	3.5	m	
Dimensional stability				
Dimension stability arising from changes in temperature	A2	9.7	mm/m·K	EN 438-2
	Durable	10.5	mm/m·K	
	Uni	10.5	mm/m·K	
	Ply	9.7	mm/m·K	
Expansion due to moisture between conditions of 23°C/50% RH and 23°C/95% RH	A2	0.206	mm/m	EN 438-2
	Durable	0.302	mm/m	
	Uni	0.303	mm/m	
	Ply	0.241	mm/m (after 4 days)	

* Depending on the sub-construction. For more information please contact us.

** With the exception of Rockpanel Metals Aluminium White and Aluminium Grey and all Rockpanel Chameleon boards (S_d value > 3,5).

Product properties

Unique by nature

The sustainable board material Rockpanel is - like all ROCKWOOL products - produced from the natural raw material basalt. This is the volcanic rock from which all ROCKWOOL products derive their unique properties.

Design advantages



Colour stable

Rockpanel boards are treated with a water-based coating that maintains their appearance, colour and finish for years to come. The table below shows the performance of the Rockpanel boards after a weathering test of 3000 and 5000 hours. This represents the weathering on a vertical south-facing facade.

The ProtectPlus coating is applied as standard on Rockpanel Premium, Woods, Stones, Metals and Chameleon.

Colour stability			
Product	Value 3000 hours	Value 5000 hours	Unit
Premium	4-5	4 or better	Greyscale
Colours	4	3-4 or better	Greyscale
Colours (ProtectPlus)	4-5	4 or better	Greyscale
Woods	4-5	4 or better	Greyscale
Stones	4-5	4 or better	Greyscale
Metals	4-5	4 or better	Greyscale
Chameleon	4-5	4 or better	Greyscale
Lines ²	4	3-4 or better	Greyscale
Uni	-	3 or better	Greyscale

Standard: EN 20105-A02



Bending and curving

The boards can easily be curved and bent in any form you require, supporting your freedom of expression and creativity. The advised minimum bending radius is determined by the bending strength of Rockpanel boards, assuming that the board is bent lengthwise.

See page 137 for more information.



Dimensionally stable

Dimensional stability, or resistance to changes in length and width, is determined by a material's tendency to expand as a result of temperature and/or moisture (moisture absorption). The unique composition of Rockpanel means that the boards are virtually immune to dimensional change caused by temperature or relative humidity.

See page 137 for guidelines on seamless installation.

Horizontal and vertical joints

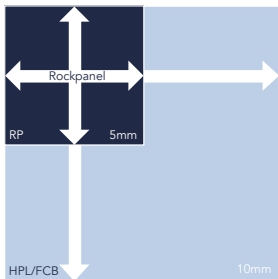

Linear elongation due to temperature fluctuation

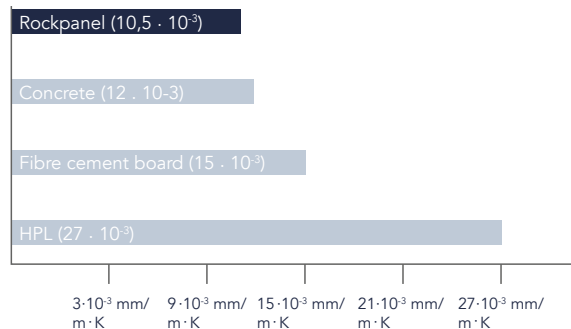

Fire safety

Rockpanel board material has been tested extensively and is classified as a fire safe building material. In case of fire, the stone wool structure remains fully intact and there will be absolutely no drop formation and the risk of fire spreading is prevented.

The boards are minimum B-s2,d0 classified and are also available in A2-s1,d0.

For all medium and high rise buildings we recommend the use of our A2 grade boards (A2-s1,d0).

Check national regulations for information on fire barriers.

Product	Fire class*	Standard
Durable	B-s1,d0	EN 13501-1
A2	A2-s1,d0	EN 13501-1

* Depending on the sub-construction. For more information please contact us.



Always in matching colours

The RAL colours of Rockpanel can be matched to window frames or other building elements. Facade finishing and paintwork in compatible RAL colour can therefore give your building a smooth and seamless look.



Non-directional

The Rockpanel boards are non-directional. The appearance of the board is the same regardless of the orientation in which it is mounted. This guarantees more efficient and swifter installation since fitting is simplified and waste reduced. Therefore during processing there is no marking of installation direction required.

Please note this applies only to Rockpanel Uni, Colours, Metals and Chameleon.



A corner solution for every building

For every corner Rockpanel offers the right solution. Use a corner profile in exactly the same RAL colour, or simply touch up paint for the edges if required. For the real craftsman you can achieve a perfect corner finish using a mitre saw.

See page 136 for the possibilities.

Installation advantages



Strong and flexible

Rockpanel combines the advantages of stone and wood in one product. It is as durable as stone and can be worked as easily as wood. A curved facade can easily be installed.



Light-weight

With Rockpanel board material you can work more quickly and easily. The boards are considerably lighter than other board materials. A standard Rockpanel board weighs only 8,4 kg/m², making it easy to handle on site.

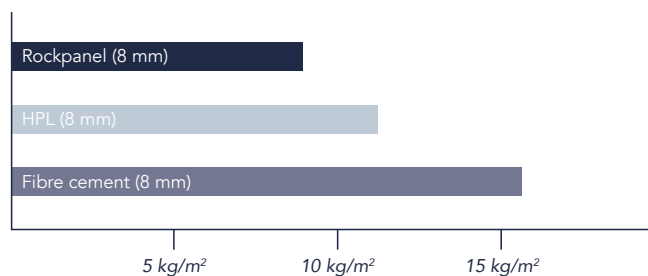

Insensitive to moisture

With Rockpanel boards moisture problems are history. Rockpanel is insensitive to moisture and temperature so does not require edge treatment. Moisture will not change the mechanical or optical properties.

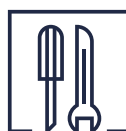

Working with standard tools

Rockpanel can be worked using standard carpentry tools. It is easier and much faster to work than other board materials. Easy to saw to size and install without pre-drilling again avoiding risks and costly site delays.



Butt joints

Rockpanel is dimensionally stable, and therefore resistant to changes in length and width arising from changes in temperature and humidity. This guarantees a sleek result without joints.

See page 137 for the conditions of seamless installation.



Detailing on the building site

With Rockpanel you can complete detailing quickly and easily. Finishing the edges to protect them from moisture is not necessary.

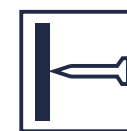

Fixing with nails

With Rockpanel you can fix the boards with nails on the building site. The discreet nail heads in a compatible RAL colour ensure a beautiful end result.



Fixing without pre-drilling

Unlike other board materials, Rockpanel boards are dimensionally stable. Pre-drilling is not required but recommended when fixing the boards on a timber frame using Rockpanel screws.



Working with Rockpanel

Packaging, transport and storage

Rockpanel is a light-weight, decorative external cladding product which weighs less than many other board materials. The products should always be handled with care by taking the following guidelines into account:

Storage in warehouse and building site

- Store the board material in dry, flat, frost-proof and protected conditions;
- Store on flat pallets and place the pallets on a level foundation. Preferably with PE-foil as an underlay;
- Make sure that the board material does not have direct contact with the floor;
- Never stack more than two pallets high;
- During storage, the board material can be more affected by moisture and night-time cooling than when installed. Before installing, the boards will need some time to allow any moisture and condensation to evaporate.

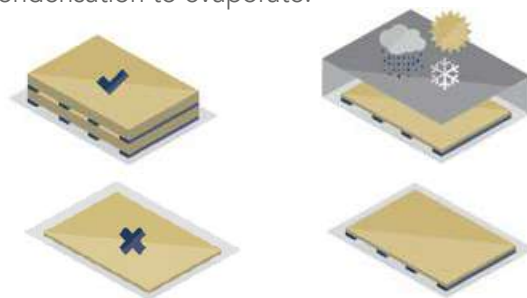

Site handling

- Individual panels must be lifted off the stack, not pulled or pushed, and carried upright;
- Protective foam membranes should be placed between the sheets again to protect the surface layer.



Protective film

- Most boards in the range are covered by a film to protect the decorative finish. Site measurements can also be marked on this film to aid the installation process. Rockpanel Natural, Rockpanel Ply, Rockpanel Lines² and Rockpanel Metals (Aluminium White and Aluminium Grey) are delivered without protective film. Handling of these boards needs extra attention.
- Remove the protective film:
 - after mounting, if attaching mechanically with screws or manual nailing;
 - before priming the board for adhesive bonding;
 - before installing when using a pneumatic hammer.

Get started with Rockpanel boards

Working with Rockpanel boards

The light-weight of Rockpanel boards allow for easy and quick installation. It also does not require any special tooling.

Safety guidelines

- Use a dust mask (type P2).
- Use standard safety spectacles to protect the eyes from dust.
- Wear gloves during sawing.

For additional information see the 'Health and safety' documentation on our website.

Indoor sawing

Use dust-reducing sawing equipment in combination with an extraction hood in a well-ventilated room.

Outdoor sawing

- Position the saw installation so that the wind blows away any dust from the sawing.
- Use dust-reducing sawing equipment if possible.

Always immediately clean the dust after cutting and drilling.

Equipment



Hand saw, e.g. a hard point saw.



Circular saw, e.g. a fine-toothed Widia/Tungsten Carbide saw blade, for example a blade with 48 teeth and a diameter of 300 mm.



Fretsaw, e.g. a fine-toothed saw blade for metal or a saw blade with tungsten coating.



Pre-drilling can be done with a HSS-steeldrill.

Sawing

Standard tools can be used for sawing Rockpanel boards or making penetrations and cut-outs in the board material. In general the boards should be sawn with the decorative side facing upwards and with the protective film still in place. It is advised that when cutting boards with a hand-held circular saw the decorative side is facing downwards. Ensure that there is a clean, smooth surface for doing this.

Drilling

- Pre-drilling of Rockpanel boards is not required but recommended. Screw holes (Ø 3.2 mm) or holes for nailing (Ø 2.5 mm) can be pre-drilled with a HSS-steeldrill.
- With rivets, fixed anchorages are advised to be drilled at Ø 5.2 mm and a sliding attachment with Ø 8 mm. Predrilling can be done with a HSS-steel-drill.
- When fixing Rockpanel Lines² 10 mm Rockpanel recommends the use of flat headed screws or manual nailing with ring shank nails. When using 2.1/2.3 x 27 mm ring shank nails pre-drilling to Ø 2 mm is recommended. When using 3.5 x 30 mm stainless steel flat headed screws, pre-drilling to Ø 3.5 mm is recommended and also drilling to countersink the flathead.

No edge finishing

- Protecting sawn edges from moisture is not needed with Rockpanel boards.
- Chamfering is easy using the reverse (non-decorative) side of a leftover Rockpanel strip to lightly sand and edge.
- If required for aesthetic reasons the side edges can be painted in a corresponding RAL/NCS colour. Without finishing the edges naturally age within several months to a grey-brown colour.

Sub- construction

Ventilated facade

Rockpanel boards are applied as a ventilated facade cladding. A ventilated facade is a secondary defence system, also known as rainscreen. Ventilating facades built with Rockpanel boards counterbalance the effects of moisture, help to lower energy consumption both during summer and winter time, and make a positive contribution to healthy, safe and enjoyable living places thanks to their aesthetic design together with fantastic climatic and fire safety properties.

Ventilated facades, whether they are with open or closed construction, need to have sufficient ventilation openings. For proper ventilation, the sub-construction must have ventilation openings of at least 5000 mm² per meter of the length. The openings must be made at both the top and bottom of the cladding. The size of the openings should be between 5 and 10 mm wide. It is advised to apply the anti-insect mesh to prevent insects and rodents from entering the ventilation cavity. The depth of the ventilated cavity should be at least 20 mm. In case of using timber battens the cavity needs to be 28 mm.

Open facade

The open system works with open joints, whereby a small amount of rainwater may enter the cavity behind the panels. Any penetrating water will either drain away or be removed by the airflow in the cavity. In addition it must be ensured that the air cavities on different elevations of a building are separated from each other by cavity closers, so that there is no increase in wind load (see drawing).

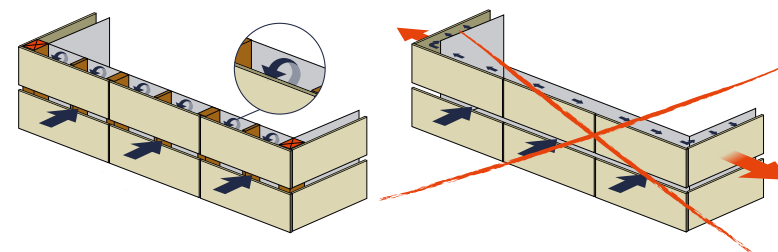

To be able to calculate the fixing distances as with open joints (which means reducing the wind load with pressure equalisation and achieving wider fixing distances), application needs to be done according the following pre-conditions:

- See drawing.
- $5 \text{ mm} \leq \text{horizontal open joints} \leq 8 \text{ mm}$.
- Open joints represent $\geq 0,10 \%$ of the total surface.
- Cavity closers should be used to prevent accumulation of wind loads (see also drawing above).
- Cavity should be at least 40 mm deep (maximum 100 mm).
- UV-resistant breathable membrane (in case of timber sub-construction).

Horizontal joints

With an open facade, the horizontal joints should have a joint of a minimum 5 mm and maximum 8 mm width.

- When using open joints in a timber construction, the structure behind the vertical batten should be protected with a breathable, water repellent and UV resistant membrane. The cavity between the Rockpanel board and the breathable membrane should be minimum 28 mm or greater. It would be beneficial to have a cavity between 40 - 100 mm to make use of pressure and to prevent penetration of excessive rainwater. For those panel systems requiring NHBC approval, a cavity of 38 mm is required.
- With an aluminium construction Rockpanel recommends a cavity depth of 40 - 100 mm. The insulation should comply with the standard BS-EN 13162 e.g. ROCKWOOL Rainscreen Duoslab.

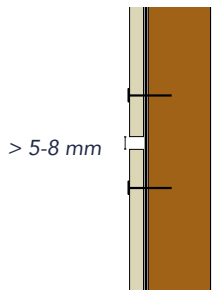

Timber sub-construction,
open horizontal joint

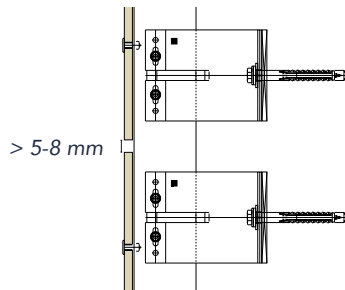

Aluminium sub-construction,
open horizontal joint

Vertical joints

The vertical joints are automatically closed by the backing of the vertical sub-construction. To ensure the durability of the timber, the vertical battens must be well protected against rain water. This can be done with a UV- and weather-resistant EPDM gasket that is 15 mm wider on both sides than the framework. It can also be done with a strip of Rockpanel, which acts as gasket to protect the battens.



Timber sub-construction,
vertical joint solution with
EPDM gasket

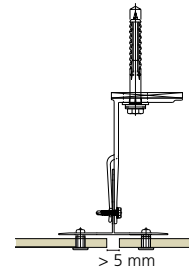

Aluminium sub-construction,
vertical joint solution

Sub- construction

Closed facade

Horizontal joints

For a closed facade the horizontal joints are closed with a profile, usually a chair or nose profile (semi-closed). Thus the rainwater is drained off as much as possible on the outer side of the cladding. The supporting structure must be ventilated. For example retaining a 20 mm cavity width behind the cladding and 5 mm continuous opening (or equivalent slots) at top and bottom. Further, ventilation must be provided in vertical runs exceeding 20 m. For those panel systems requiring NHBC approval, a cavity of 38 mm is required. For timber sub-construction a cavity of 28 mm is required, in regards to the minimal thickness of the batten.

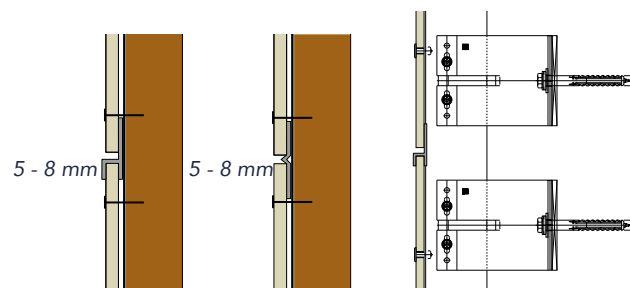

Timber sub-construction with closed (left) and semi-closed (right) horizontal joint

Aluminium sub-construction with closed horizontal joint

Vertical joints

The vertical joints are automatically closed by the backing of the vertical sub-construction. To ensure the durability of the timber, the vertical battens must be well protected against rain water. This can be done with a UV- and weather-resistant EPDM gasket or a strip of Rockpanel. With a closed joint, the gasket does not need to protrude.

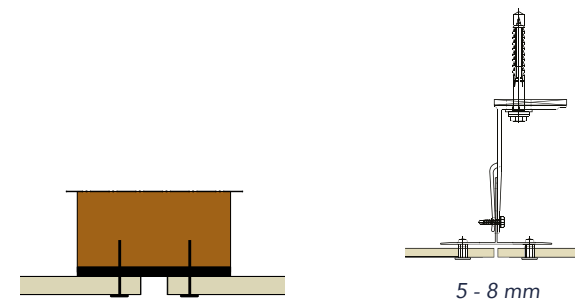

Timber sub-construction, vertical joint solution with EPDM gasket

Aluminium sub-construction, vertical joint solution

Alternative applications

Thanks to its unique characteristics and the vapour-open structure of Rockpanel Colours (without a ProtectPlus layer) this product can be used in specific situations in non-ventilated structures. In situations where the pre-conditions can easily be fulfilled, for example such as infill panels and dormers, the absence of a cavity can allow for thicker insulation which leads to a lower U-value.

See page 157 for technical detailing.

Pre-conditions for non-ventilated applications

- interior climate with a maximum vapour pressure of 1320 Pa (normal housing and office buildings i.e. no swimming pools or factories);
 - the sum of the $S_{d,i}$ -values of the materials on the inside of the structure down to the insulation should add up to at least 10 m, this value can be achieved with a 0.15 mm thick PE-membrane as vapour barrier and drywall;
 - the sum of the $S_{d,e}$ -values of the materials on the outside of the structure down to the insulation should add up to less than 2.5 m;
 - the inside of the structure should be airtight so that no warm air, containing moisture, can penetrate through the structure;
 - the attachments of the boards to the structure should be watertight, so that no rainwater or cleaning water can get behind the cladding. This means that horizontal joints between the Rockpanel boards are not allowed. Vertical joints can be applied but should abut at a timber batten covered with a 3 mm x 60 mm soft adhesive EPDM foam gasket;
 - can be applied on small surfaces and as infill panels;
- only Rockpanel Colours without ProtectPlus can be used in this application. The $S_{d,i}$ -value from Rockpanel Colours without ProtectPlus is 1.8 m.

If you are unsure whether the construction meets these conditions, please contact Rockpanel: www.rockpanel.co.uk/contact.

Sub- construction

Sub-construction materials

Rockpanel boards can be applied to sub-constructions made of timber, aluminium or steel. For detailed information about sub-construction materials, please consult the European Technical Assessment (ETA) of the relevant Rockpanel product and your sub-construction supplier.

Timber sub-construction

Timber stud walls and timber battens fixed to masonry walls should be constructed in accordance with BS EN 1995-1-1 and preservative treated in accordance with EN 335 and BS 8417. Studding and framing should be adequately supported by noggings to ensure rigidity. Where timber stud walls or battens are treated with cuprous preservatives, care must be taken to ensure that sufficient time is allowed for the preservative to properly condition before the cladding is fixed.

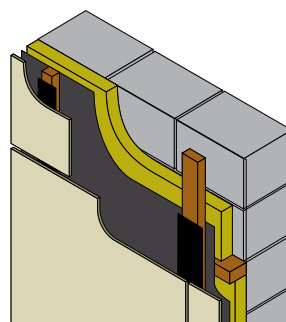

Aluminium sub-construction

When Rockpanel boards are applied to aluminium sub-construction the following requirements should be met:

- The aluminium alloy is AW-6060 according to BS EN 755-2:
 - $R_m/R_{p0,2}$ value is 170/140 for profile T6
 - $R_m/R_{p0,2}$ value is 195/150 for profile T66
- The minimum thickness of the profile is 1.5 mm.

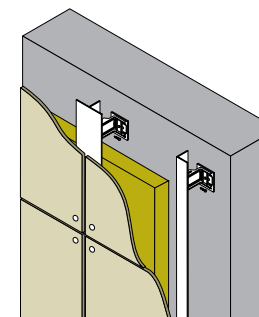

Steel sub-construction

The minimum thickness of the vertical steel profiles is either 1.0 mm (steel quality is S320GD +Z EN 10346 number 1.0250, or equivalent for cold forming), or 1.5 mm (steel quality EN 10025-2:2004 S235JR number 1.0038).

The minimum coating thickness (Z or ZA) is determined by the corrosion rate (amount of corrosion loss in thickness per year) which depends on the specific outdoor atmospheric environment. The Zinc Life Time Predictor can be used to calculate the Corrosion Rate in $\mu\text{m}/\text{y}$ for a Z coating: <http://www.galvinfo.com:8080/zclp/> [copyright The International Zinc association]. The coating designation (classification which determines the coating mass) shall be agreed between the contractor and the building owner. Alternatively, a hot dip galvanized coating according to EN ISO 1461 can be used.

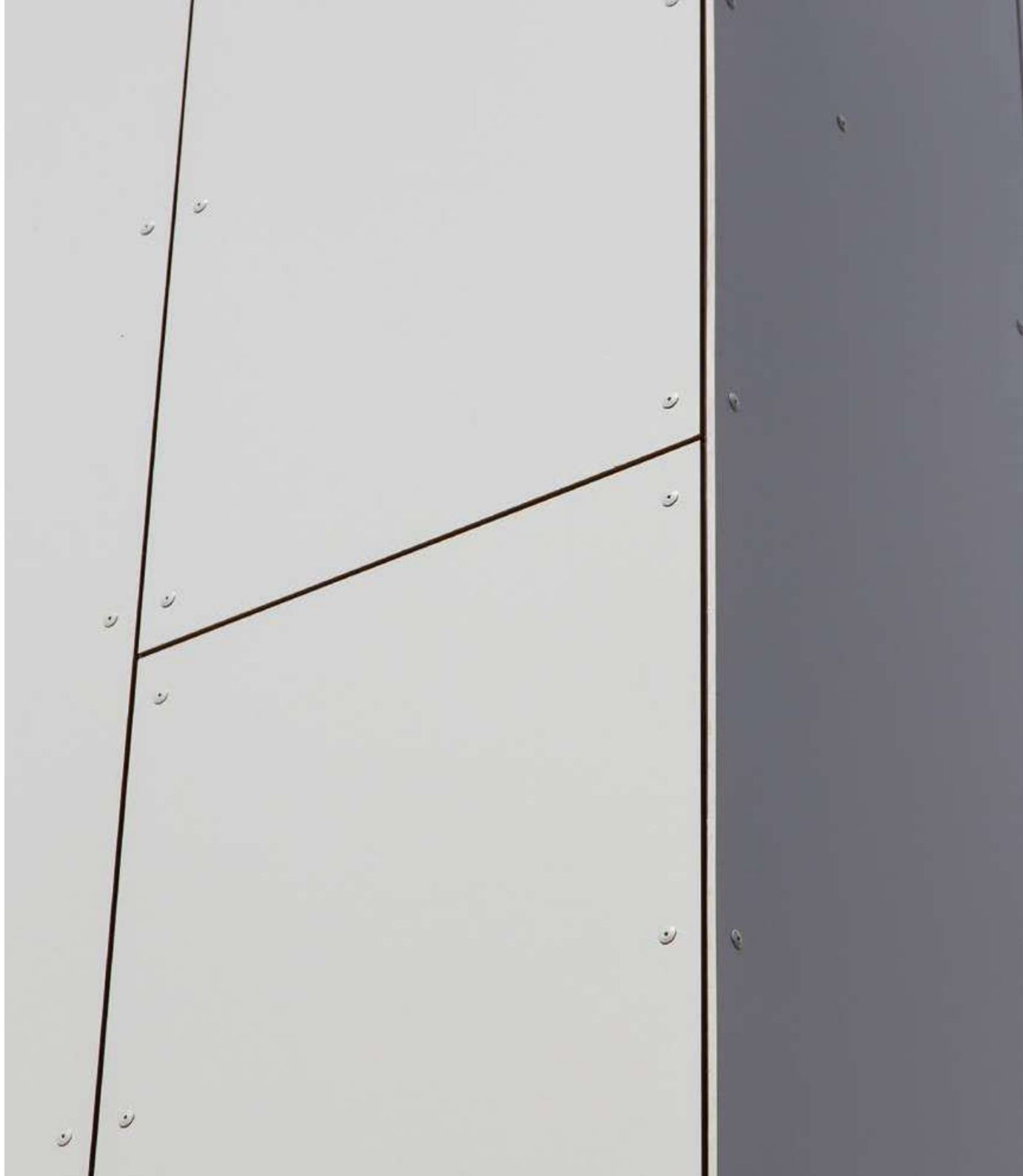
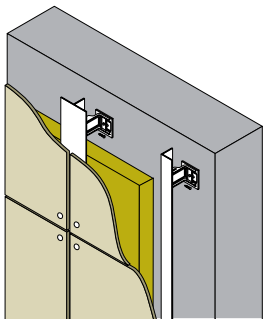

Fixing

Rockpanel can be installed with a broad range of fixings; nails, rivets, screws as well as a certified fire safe and invisible concealed fixing system (Euroclass A2-s1,d0) and adhesive system (Euroclass B-s2,d0). All are suitable and mechanically tested to be applied in combination with our board material.

Always ensure with the fixings supplier the suitability of their fixings to meet the technical requirements of Rockpanel as documented in the Declaration of Performance (DoP). Always check that fixings are suitable for the design and its associated performance requirements. It is further recommended to use only coloured fixings with a durable finish. Working with fixings from other manufacturers should be carried out according to their recommendations, their supervision.

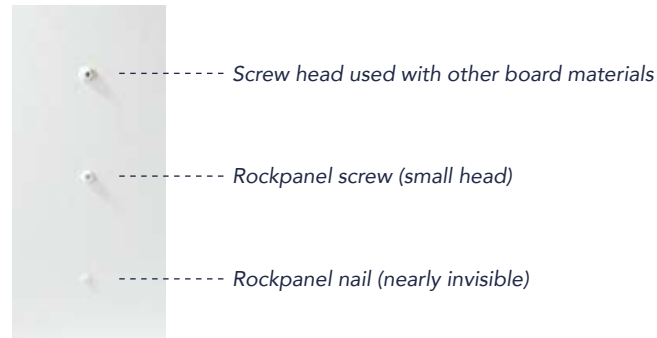

Fastening Rockpanel boards to timber sub-construction is carried out with:

- Mechanical fixings: corrosion resistant nails and screws;
- Rockpanel EasyFix clip is used for a ship lap construction
- Special nails and screws are used for our tongue-and-groove panels Lines² 10 mm
- Adhesive installation system (with an intermediate Rockpanel strip with specified finish)

Fastening to aluminium sub-construction is carried out with:

- Corrosion resistant rivets for aluminium
- Adhesive installation system
- Concealed fixing

Fastening to steel sub-construction is carried out with:

- Corrosion resistant rivets for steel
- Screws for steel

Mechanical fasteners, gaskets, adhesives with primers, strips for bonding, and sub-construction profiles are specified by the ETA-holder. For more information see the product data sheet or consult the appropriate ETA, available on our website.

Fixing to timber sub-construction

Mechanical fixing to timber

Mechanical fixing to timber can be carried out with:

- Rockpanel ring shank nails (stainless steel material number 1.4401 or 1.4578) 2.7/2.9 x 32 mm (flat-top).
- Rockpanel High Performance nails (stainless steel material number 1.4401 or 1.4578) 2.7/3.1 x 35 mm (flat top)
- Rockpanel Torx screws (stainless steel material number 1.4401 or 1.4578) 4.5 x 35 mm. Nail heads in the same RAL colour combine perfectly with the RAL colour of the board material.

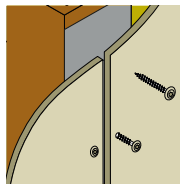
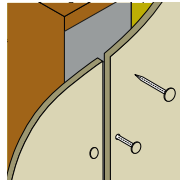

Screwing

Rockpanel board material can be fixed mechanically with nails or screws. With a timber subframe and mechanical fastening with screws, Pre-drilling of the Rockpanel boards is not required but recommended. Screw holes (Ø 3.2 mm) can be pre-drilled with a HSS-steeldrill.

The boards can be mechanically installed on the construction site.



Screw Ø 9.6 mm (head diameter)

Nailing

Rockpanel nails can be attached with either a nylon hammer or nail gun. Pre-drilling is not required but recommended. Holes for nailing holes (Ø 2.5 mm) can be pre-drilled with a HSS-steeldrill.

For a perfect match to the board material, the nail and screw heads can be provided with a RAL/NCS colour coating.



Nail Ø 6.0 mm (head diameter)

EasyFix Clip; for a ship lap construction

Rockpanel has developed a secret fixing system for cladding boards in 8 mm using a mousing spacer called Rockpanel EasyFix. The EasyFix clip allows a simple and stress free assembly by acting as a guide to locate the screw fixings.

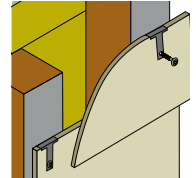

Rockpanel board sizes

Gross width (b)	Effective width (b _w)
285 - 340 mm	b - 60 mm

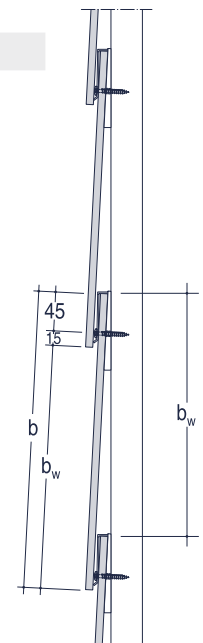

Fixing

Adhesive installation on Rockpanel strips on timber sub-construction

In collaboration with Rockpanel, Bostik has developed a firesafe (B-s2,d0) European certified adhesive system compatible with European Technical Assessments of Rockpanel, Rockpanel Tack-S. For more information, see the product data sheet or consult the appropriate ETA (e.g. for Durable ETA-07/0141). If you wish to use an alternative adhesive system, always verify that the chosen system meets the requirements for application with Rockpanel. If using another adhesive system, the adhesive supplier becomes responsible for certification and guarantee. The quality of the adhesive installation is partly determined by the weather conditions during application. For more information refer to the adhesive supplier.

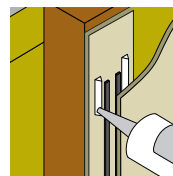

Fixing Rockpanel Lines²

Rockpanel Lines² are tongue-and-groove cladding boards suitable for horizontal application in ventilated constructions. The panels are available in a small (S) and an extra wide (XL) version. The thickness available is 10 mm. Rockpanel Lines² can be applied with:

- Rockpanel ring shank nails (stainless steel material number 1.4401 or 1.4578) 2.1/2.3 x 27 mm (flat-top).
- Stainless steel flat-top screws of 3.5 x 30 mm with a head diameter of Ø 6.6 mm. The tongue should be predrilled with a steel drill Ø 3.5 mm and the hole for the flat-top screw head should be sunk with a countersink bore. The top of the screw head should be level with the surface of the tongue. Tension in the mounting of the tongue can be avoided by tightening to an appropriate level and by ensuring they are driven into the batten in a true fashion.

Rockpanel Lines² 10 tongue-and-groove panels

The Lines² 10 tongue-and-groove panels can be fixed invisibly by means of Rockpanel ring shank nails or flat-top screws, which results in a traditional tongue-and-groove effect.

Type	Panel width	Working panel width
Rockpanel Lines ² S10	164 mm	146 mm
Rockpanel Lines ² XL10	295 mm	277 mm

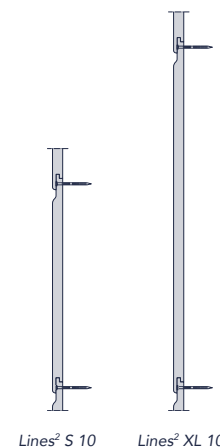

Fixing to aluminium sub-construction

Mechanical fixing to aluminium sub-construction with rivets

For the mounting of Rockpanel on aluminium load-bearing sections, Ø 14 mm AP14-50180-S flat-topped aluminium rivets can be used:

- Material EN AW-5019 in conformity with EN 755-2.
- Material number of the rivet 1.4541 in conformity with EN 10088.

When installing Rockpanel boards on aluminium load-bearing sections, fixed points, slotted holes and moving points should be applied.

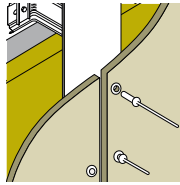

Adhesive installation on aluminium sub-construction

In collaboration with Rockpanel, Bostik has developed a fire safe (Euroclass B-s2,d0) European certified adhesive system compatible with European Technical Assessments of Rockpanel, Rockpanel Tack-S. For more information, see the product data sheet or consult the appropriate ETA (e.g. for Durable ETA-07/0141). If you wish to use an alternative adhesive system, always verify that the chosen system meets the requirements for application with Rockpanel. If using another adhesive system, the adhesive supplier becomes responsible for certification and guarantee. The quality of the adhesive installation is partly determined by the weather conditions during application. For more information, refer to the adhesive supplier.

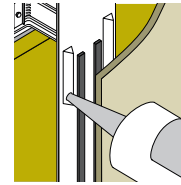

Concealed fixing to aluminium sub-construction

For mounting of Rockpanel Premium boards with invisible concealed fixing on aluminium load-bearing sections TU-S 6x13 blind fastener is used for secret fixing clip in thickness of 5 mm or TU-6x11 blind fastener for fixing clip in thickness of 3 mm. Body of blind fastener is made of stainless steel material number 1.4401 in accordance with EN 10088, with electro-galvanised carbon steel mandrel.

See ETA-18/0883 or contact Rockpanel for more information.

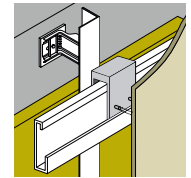

Fixing

Fixing to steel sub-construction

Mechanical fixing to steel sub-construction with rivets

For the mounting of Rockpanel on steel load-bearing sections, either EN 10088 (no 1.4578) rivets, head diameter 15 mm, body diameter 5 mm, head colour coated, or EN 10088 (no 1.4567) rivets, head diameter 14 mm, body diameter 5 mm, head colour coated, can be used. For correct fixing, a riveting tool with rivet spacer must be used.

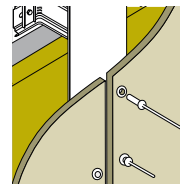

When installing Rockpanel boards on steel load-bearing sections, fixed points, slotted holes and moving points should be applied.

Mechanical fixing to steel sub-construction with screws for steel

For the mounting of Rockpanel on steel load-bearing sections, steel EJOT screws JT6-FR-3-5,5x35 and JT6-FR-3-5,5x25 can be used.

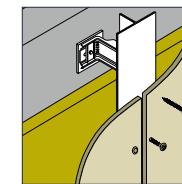

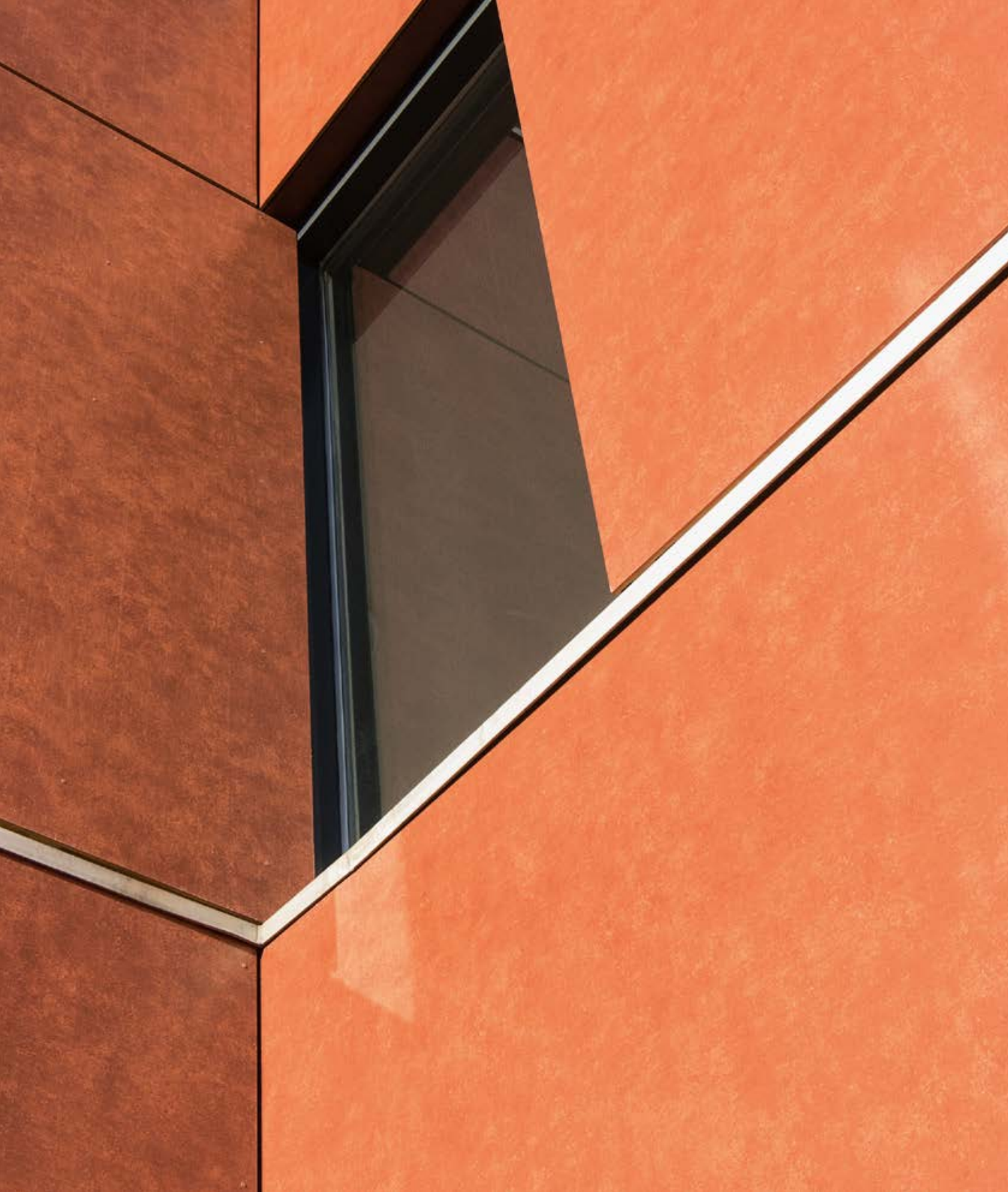

Fixing

Tension-free fixing

Cladding boards have to be mounted free from tension. In the event of tension e.g. as a result of difference in elongation between a metal sub-construction and the cladding boards, fixed points, slotted hole and moving points must be applied.

Fixed points, slotted hole and moving points can be applied in several ways. Boards can be applied with 2 fixed points and several moving points or in a combination of 1 fixed point, 1 or 2 slotted holes and several moving points. The next section will show the several possibilities.

Key fixing possibilities:



MP = Moving point, \varnothing according ETA



FP = Fixed point or fixed point created by sleeve, \varnothing according ETA



SP = Slotted point or slotted point created by sleeve, \varnothing according ETA

Principle fixed points and moving points

Each panel, no matter what size, will have 2 fixed points or 1 fixed point combined with 1 or 2 slotted points. The fixed points and slotted points support the weight of the panel and ensure the panel stays in position. All others will be moving points.

Correct application of the slotted point and moving point:

- It is important to prevent clamping of the fastener. Clamping by over-tight rivets can be prevented by the use of a rivets spacer. The rivet spacer ensures a 0,3 mm distance between the head of the rivet and the surface of the Rockpanel board by which the rivet easily can move in the moving points.
- Fasteners located in slotted holes or moving points must be able to move. Therefore it's important to position the fastener exactly in the middle of the slotted hole or moving point. To ensure the fastener is exactly in the middle a centre tool or centre drill can be used.
- Fixed points are arranged in the centre of the facade panel if possible, if possible symmetrically and are always close to a horizontal centre-line of the plate.

Tip for simple and quick installation

Holes for fixed points, moving points and slotted points can be drilled directly in the board or in the event of slotted hole created with a router. Alternatively, all holes can be drilled as moving point after which a sleeve will be used to narrow the hole and to create the fixed points or slotted points. Different sleeves are available for fixed points and slotted points. In the event of using sleeves it should be considered that the maximum distance between a fixed point and a side sleeve (sleeve used in the slotted point) is limited to 600 mm. For correct application of the sleeves a proper positioning tool should be used.

The examples below are given for a correct vertical or horizontal orientated application.

Examples by vertical orientated boards > 8 mm:

Figure 1:
Combination fixed point and slotted points

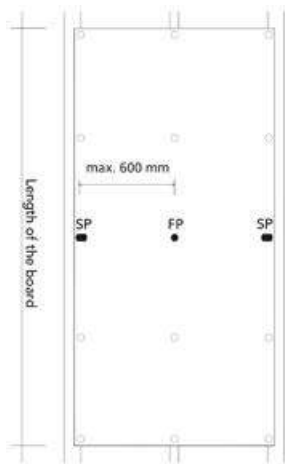
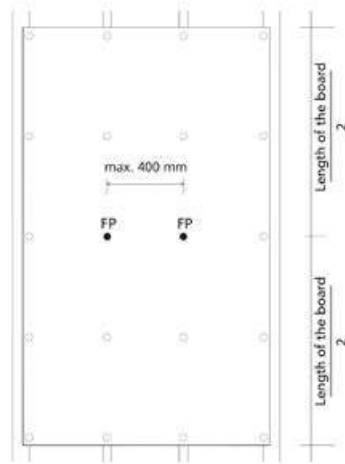

Figure 2:
Combination of 2 fixed points



Examples by horizontal orientated boards > 8 mm:

Figure 3:
Combination fixed point and slotted points in symmetric way

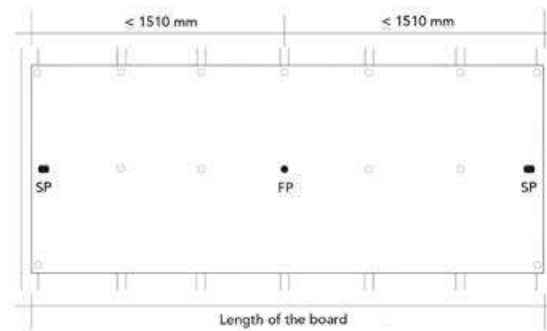

Figure 4:
Combination fixed points and slotted point in symmetric way

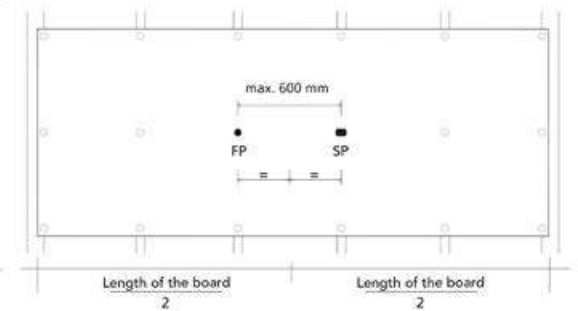
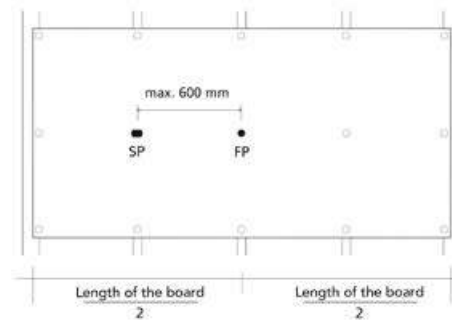

Figure 5:
Combination of fixed and slotted point in asymmetric way



Fixing

Fixing guidelines

In this section the mounting guidelines and maximum fixing distances are indicated for facade panels, tongue and groove panels and gutter trims on timber support structures and for facade elements on aluminium support structures on the basis of boundary conditions, data and material properties.

The fixing distances are shown for 6 mm, 8 mm Durable grade boards and 6 mm, 8 mm Uni grade boards. For all medium and high rise buildings, we recommend the use of our A2 grade boards (A2-s1,d0). Project specific calculations are available on request.

The fixing distances for Rockpanel Lines² tongue and groove panels give the maximum permitted building height for attachment to timber support structures.

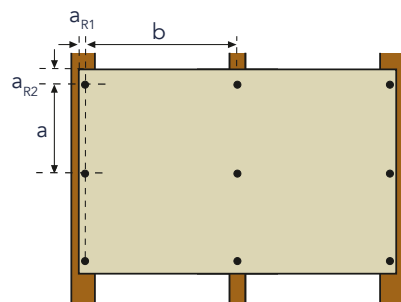

Edge distance a_{R1} (board thickness ≤ 8 mm) : 15 mm
 (board thickness ≥ 9 mm) : 20 mm
 Edge distances $a_{R2} \geq 50$ mm

Distances between fastening points

The table below shows the maximum fixing distances at a vertical timber sub-construction or aluminium sub-construction in accordance with ETA-07/0141, ETA-08/0343 for Durable boards and ETA-17/0619, ETA-17/0620 for Uni boards.

Rockpanel Durable 6 mm

Fastening system	Maximum span (b)	Maximum distance between Fasteners (a)
Rockpanel screw	400 mm	300 mm
Rockpanel ring shank nail	480 mm	300 mm

Rockpanel Durable 8 mm*

Fastening system	Maximum span (b)	Maximum distance between Fasteners (a)
Rockpanel screw	600 mm	600 mm
Rockpanel ring shank nail	600 mm	400 mm
Rivet	600 mm	600 mm

Adhesive system: The maximum span between the adhesive beads at an 8 mm board will be 600 mm (b)

* Maximum distances are not applicable for Rockpanel Natural.

Rockpanel Uni 6 mm

Fastening system	Maximum span (b)	Maximum distance between Fasteners (a)
Rockpanel screw	400 mm	300 mm
Rockpanel ring shank nail	480 mm	300 mm

Determining the fixing distances

The following steps should be followed to determine the fixing distances:

- Determine the design wind load
 - define wind zone
 - define terrain category
 - define area on the facade
 - zone A for corner area and B for middle area (take into account the rules in standard EN 1991-1-4, if unknown or facades are very small use zone A as normative value)
 - look up in the table the design wind load in kN/m^2
- Determine the fixing distances
 - choose the correct table by:
 - static load absorption, for example 1-field span (b) or 2-field span (b)
 - type of board and thickness (e.g. Durable 8 mm)
 - fastening system
 - look up the preferred span - combine with the wind load of step 1: result is the fixing distance between the fasteners

Take into account local requirements.

Horizontal applications

If Rockpanel board material is used horizontally, for example in a ceiling application, the specific weight of the board must be taken into account in the calculation of the fixing distances. As a rule of thumb, the fixing distances can be multiplied by 0.75.

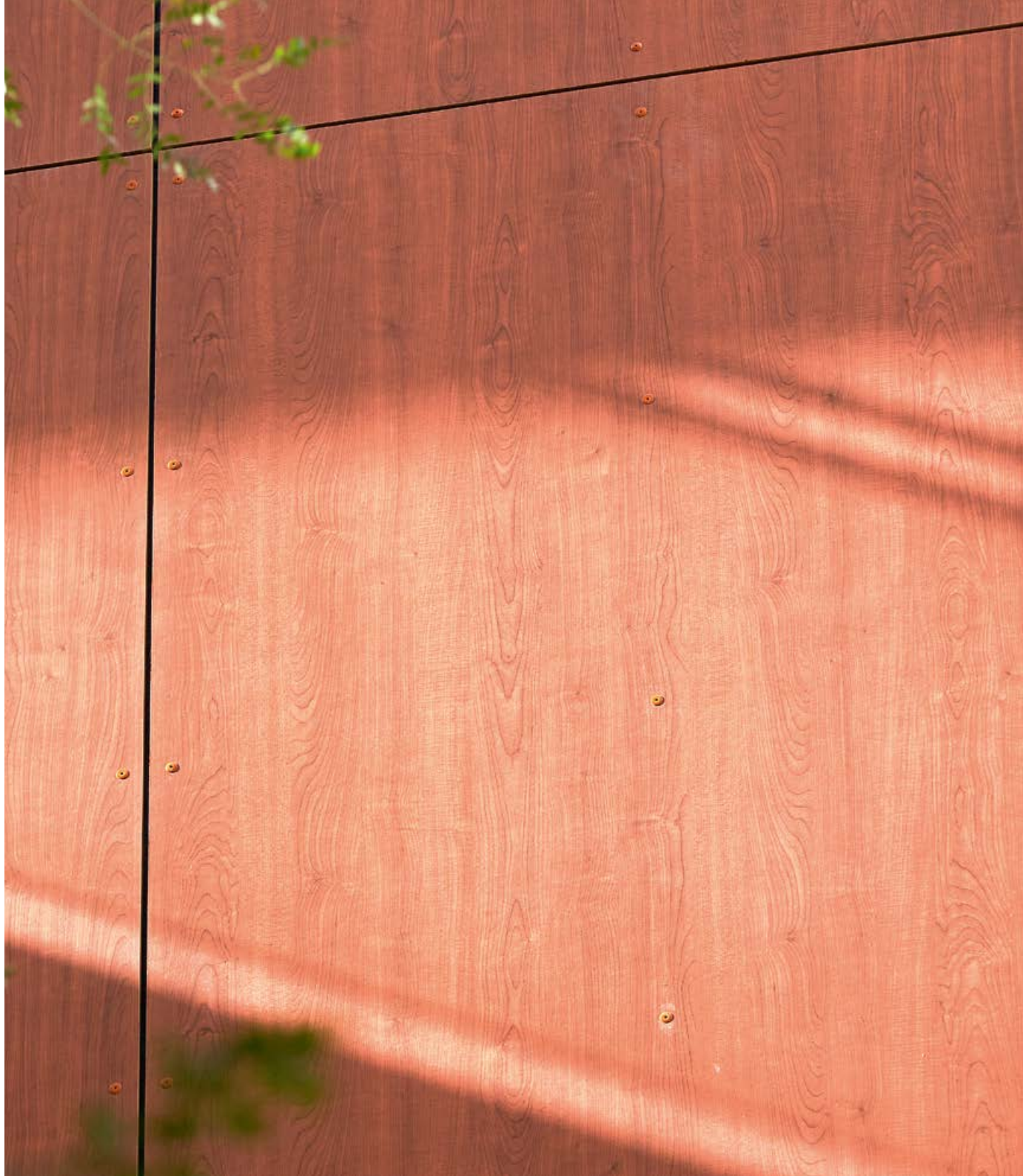

Fixing

Basic wind velocity (m/s)

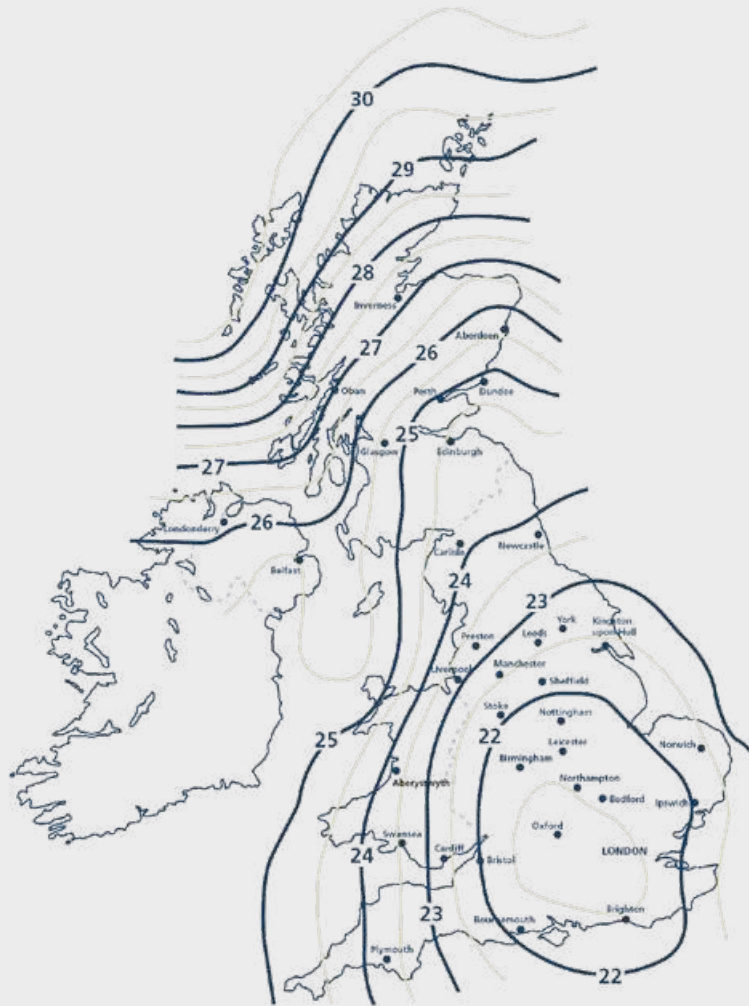

This map is an indication of the fundamental basic wind velocity according to BS-EN 1991-1-4. If you are unsure which zone the building is located please contact Rockpanel.

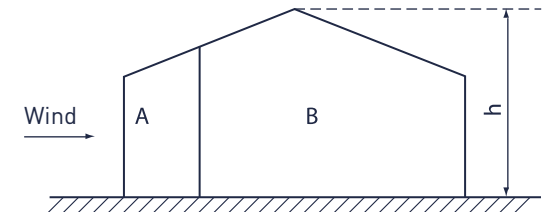

A = Corner area
B = Area between the corners
h = Total building height

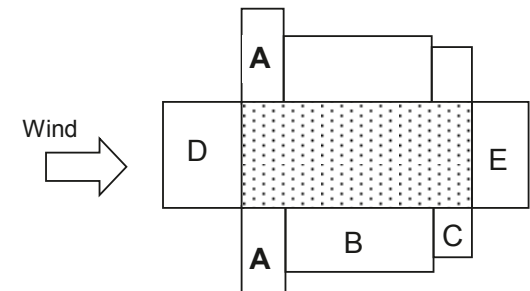

Design wind load (calculation value $F_d = F_{rep} * \gamma_F$) in kN/m² at building height ≤ 10 m

			Value of fundamental basic wind velocity $v_{b,map}$ (m/s)										
United Kingdom			28		26		25		23		22		
			Zone	A	B	A	B	A	B	A	B	A	B
Terrain category - Country	Distance upwind to shoreline (km)	≤ 0.1 to 1 km	-2.64	-1.76	-2.28	-1.52	-2.11	-1.41	-1.78	-1.19	-1.63	-1.09	
		1 to 10 km	-2.57	-1.71	-2.22	-1.48	-2.05	-1.37	-1.73	-1.16	-1.59	-1.06	
		10 to 100 km	-2.33	-1.55	-2.01	-1.34	-1.85	-1.24	-1.57	-1.05	-1.44	-0.96	
		≥ 100 km	-2.18	-1.46	-1.88	-1.26	-1.74	-1.16	-1.47	-0.98	-1.35	-0.90	
Terrain category - Town located 10-100 km upwind to shoreline	Distance building into town (km)	≤ 0.4 km	-2.33	-1.55	-2.01	-1.34	-1.85	-1.24	-1.57	-1.05	-1.44	-0.96	
		0.4-1 km	-2.31	-1.54	-1.99	-1.33	-1.84	-1.23	-1.56	-1.04	-1.43	-0.95	
		1-5 km	-2.14	-1.43	-1.84	-1.23	-1.71	-1.14	-1.44	-0.96	-1.32	-0.88	
		≥ 5 km	-1.92	-1.28	-1.66	-1.11	-1.53	-1.02	-1.30	-0.87	-1.19	-0.79	

Note: Building height ≤ 10 m / Site altitude ≤ 50 m

When determining the fixing distances the following variables should be taken into account:

- Wind load
 - Determine the fundamental local basic wind velocity (map)
 - Determine the maximum height of the building (max. 10 m)
 - Determine the site altitude (max 50 m)
 - Determine the distance from the coast
 - Determine the distance to the town border
 - No frontline buildings (coast)
- Building area: zone A (corner area) or zone B (area between corners). For details see the figure below
- Type of board, thickness and fastening system
- Static load absorption, for example 1-field- or 2-field span
- Legal local requirements

Calculation examples: fixing distances Durable

Coated Rockpanel Durable boards, 8 mm thickness
Determining the fixing distances (screw, nail, rivet):

- ETA-07/0141
- Cavity closers (on the corners of the building)
- Maximum deflection of the panels 0.75 %
- Thickness gasket max. 0.5 mm
- Quality timber battens: \geq C18, service class 2 according EN 1995-1-1
- Nail length 32 mm
- $a_{R1} \geq 15$ mm
- $a_{R2} \geq 50$ mm
- If the table shows no fixing distance (-) or building height > 10 m, please contact Rockpanel for the possibilities and specific advice.
- Not applicable for Rockpanel Natural.

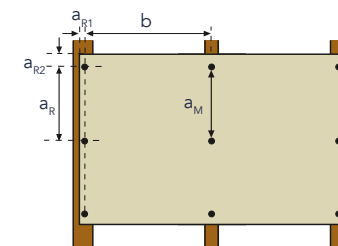

Edge distance a_{R1} (board thickness \leq 8 mm) : 15 mm
(board thickness \geq 9 mm) : 20 mm
Edge distance $a_{R2} \geq 50$ mm

Maximum fixing distance (mm) screws a_M for different c.t.c. distances (b) of the vertical sub-structure (k_{mod} : 0,90 / 1,00 / 1,10)

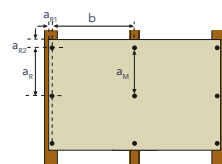

b (mm)	Design wind load on Rockpanel board ($F_d = F_{rep} * \gamma_F$) in kN/m ²												Durable 8 mm			
	-0.80	-0.90	-1.00	-1.10	-1.20	1.30	-1.40	-1.50	-1.60	-1.70	-1.80	-1.90	2.00	-2.10	2.20	-2.30
600	600	600	565	515	470	435	-	-	-	-	-	-	-	-	-	-
500	600	600	600	600	565	520	485	450	425	400	375	355	340	320	310	295
400	600	600	600	600	600	600	600	565	530	500	470	445	425	405	385	370
300	600	600	600	600	600	600	600	600	600	600	600	600	595	565	540	490

Maximum fixing distance (mm) nails a_M (length 32 mm) for different c.t.c. distances (b) of the vertical sub-structure (k_{mod} : 1.10)

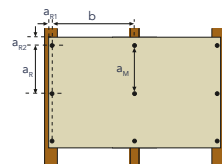

b (mm)	Design wind load on Rockpanel board ($F_d = F_{rep} * \gamma_F$) in kN/m ²												Durable 8 mm			
	-0.80	-0.90	-1.00	-1.10	-1.20	1.30	-1.40	-1.50	-1.60	-1.70	-1.80	-1.90	2.00	-2.10	2.20	-2.30
600	185	165	150	135	125	115	-	-	-	-	-	-	-	-	-	-
500	225	200	180	165	150	135	125	120	110	105	100	-	-	-	-	-
400	280	250	225	205	185	170	160	150	140	130	125	115	110	105	100	-
300	375	335	300	275	250	230	215	200	185	175	165	155	150	140	135	130

Maximum fixing distance (mm) rivets a_M for different c.t.c. distances (b) of the vertical sub-structure

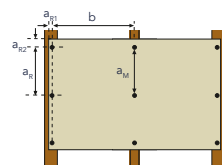

b (mm)	Design wind load on Rockpanel board ($F_d = F_{rep} * \gamma_F$) in kN/m ²												Durable 8 mm			
	-0.80	-0.90	-1.00	-1.10	-1.20	1.30	-1.40	-1.50	-1.60	-1.70	-1.80	-1.90	2.00	-2.10	2.20	-2.30
600	600	600	600	600	580	535	-	-	-	-	-	-	-	-	-	-
500	600	600	600	600	600	600	595	555	520	490	465	440	415	395	380	360
400	600	600	600	600	600	600	600	600	600	600	580	550	520	495	475	450
300	600	600	600	600	600	600	600	600	600	600	600	600	600	600	600	600

Coated Rockpanel Durable boards, 6 mm thickness
Determining the fixing distances (screw, nail):

- ETA-08/0343
- Cavity closers (on the corners of the building)
- Maximum deflection of the panels 0.75 %
- Thickness gasket max. 0.5 mm
- Quality timber battens: \geq C18, service class 2 according EN 1995-1-1
- Nail length 32 mm
- $a_{R1} \geq 15$ mm
- $a_{R2} \geq 50$ mm
- If the table shows no fixing distance (-) or building height > 10 m, please contact Rockpanel for the possibilities and specific advice.

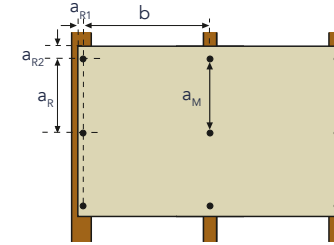

Edge distance a_{R1} (board thickness ≤ 8 mm) : 15 mm
(board thickness ≥ 9 mm) : 20 mm
Edge distance $a_{R2} \geq 50$ mm

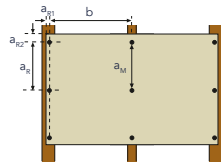

Maximum fixing distance (mm) screws a_M for different c.t.c. distances (b) of the vertical sub-construction (k_{mod} : 0,90 / 1,00 / 1,10)

b (mm)	Design wind load on Rockpanel board ($F_d = F_{rep} * \gamma_F$) in kN/m ²												Durable 6 mm			
	-0.80	-0.90	-1.00	-1.10	-1.20	1.30	-1.40	-1.50	-1.60	-1.70	-1.80	-1.90	2.00	-2.10	2.20	-2.30
400	300	300	300	300	300	300	300	300	300	300	-	-	-	-	-	-
300	300	300	300	300	300	300	300	300	300	300	300	3300	300	300	300	300

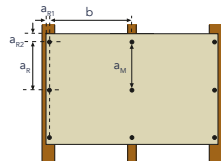

Maximum fixing distance (mm) nails a_M (length 32 mm) for different c.t.c. distances (b) of the vertical sub-construction (k_{mod} : 1.10)

b (mm)	Design wind load on Rockpanel board ($F_d = F_{rep} * \gamma_F$) in kN/m ²												Durable 6 mm			
	-0.80	-0.90	-1.00	-1.10	-1.20	1.30	-1.40	-1.50	-1.60	-1.70	-1.80	-1.90	2.00	-2.10	2.20	-2.30
400	300	300	290	265	240	225	205	195	180	170	-	-	-	-	-	-
300	300	300	300	300	300	300	275	260	240	225	215	205	195	185	175	165

Calculation examples: fixing distances Durable

Coated Rockpanel Durable boards, 8 mm thickness
Determining the fixing distances (screw, nail, rivet):

- ETA-07/0141
- Cavity closers (on the corners of the building)
- Maximum deflection of the panels 0.75 %
- Thickness gasket max. 0.5 mm
- Quality timber battens: \geq C18, service class 2 according EN 1995-1-1
- Nail length 32 mm
- $a_{R1} \geq 15$ mm
- $a_{R2} \geq 50$ mm
- If the table shows no fixing distance (-) or building height > 10 m, please contact Rockpanel for the possibilities and specific advice.
- Not applicable for Rockpanel Natural.

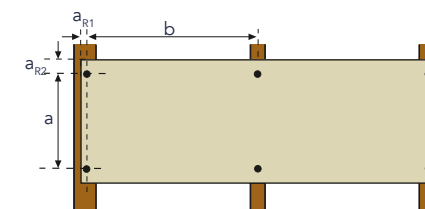

Edge distance a_{R1} (board thickness \leq 8 mm) : 15 mm
(board thickness \geq 9 mm) : 20 mm

Edge distance $a_{R2} \geq 50$ mm

Maximum fixing distance (mm) screws a for different c.t.c. distances (b) of the vertical sub-construction (k_{mod} : 0,90 / 1,00 / 1,10)

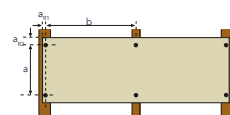

b (mm)	Design wind load on Rockpanel board ($F_d = F_{rep} * \gamma_F$) in kN/m ²												Durable 8 mm			
	-0.80	-0.90	-1.00	-1.10	-1.20	1.30	-1.40	-1.50	-1.60	-1.70	-1.80	-1.90	2.00	-2.10	2.20	-2.30
600	565	545	525	480	435	390	-	-	-	-	-	-	-	-	-	-
500	565	545	525	519	495	480	450	410	380	350	325	305	285	265	250	235
400	565	545	525	510	495	480	470	460	450	440	430	405	380	355	335	315
300	565	545	525	510	495	480	470	460	450	440	430	420	420	420	400	400

Maximum fixing distance (mm) nails a (length 32 mm) for different c.t.c. distances (b) of the vertical sub-construction (k_{mod} : 1.10)

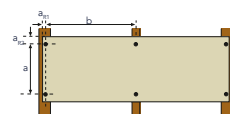

b (mm)	Design wind load on Rockpanel board ($F_d = F_{rep} * \gamma_F$) in kN/m ²												Durable 8 mm			
	-0.80	-0.90	-1.00	-1.10	-1.20	1.30	-1.40	-1.50	-1.60	-1.70	-1.80	-1.90	2.00	-2.10	2.20	-2.30
600	370	320	275	240	215	190	-	-	-	-	-	-	-	-	-	-
500	400	400	350	310	275	245	220	200	180	165	150	135	125	115	105	-
400	400	400	400	400	370	335	305	275	255	230	215	195	180	170	155	145
300	400	400	400	400	400	400	400	400	370	345	320	275	275	260	240	225

Maximum fixing distance (mm) rivets a for different c.t.c. distances (b) of the vertical sub-construction

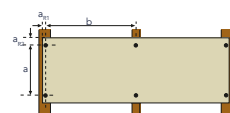

b (mm)	Design wind load on Rockpanel board ($F_d = F_{rep} * \gamma_F$) in kN/m ²												Durable 8 mm			
	-0.80	-0.90	-1.00	-1.10	-1.20	1.30	-1.40	-1.50	-1.60	-1.70	-1.80	-1.90	2.00	-2.10	2.20	-2.30
600	565	545	525	510	495	480	-	-	-	-	-	-	-	-	-	-
500	565	545	525	510	495	480	470	460	450	440	425	415	390	365	345	325
400	565	545	525	510	495	480	470	460	450	440	425	425	415	410	405	400
300	565	545	525	510	495	480	470	460	450	440	425	425	415	410	405	400

Coated Rockpanel Durable boards, 6 mm thickness
Determining the fixing distances (screw, nail):

- ETA-08/0343
- Cavity closers (on the corners of the building)
- Maximum deflection of the panels 0.75 %
- Thickness gasket max. 0.5 mm
- Quality timber battens: \geq C18, service class 2 according EN 1995-1-1
- Nail length 32 mm
- $a_{R1} \geq 15$ mm
- $a_{R2} \geq 50$ mm
- If the table shows no fixing distance (-) or building height > 10 m, please contact Rockpanel for the possibilities and specific advice.

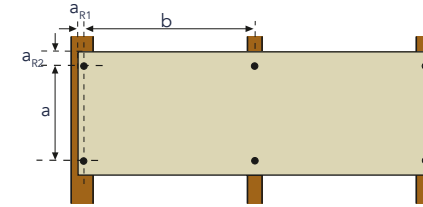

Edge distance a_{R1} (board thickness ≤ 8 mm) : 15 mm
(board thickness ≥ 9 mm) : 20 mm
Edge distance $a_{R2} \geq 50$ mm

Maximum fixing distance (mm) screws a for different c.t.c. distances (b) of the vertical sub-construction (k_{mod} : 0,90 / 1,00 / 1,10)

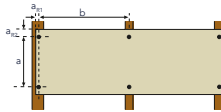

b (mm)	Design wind load on Rockpanel board ($F_d = F_{rep} * \gamma_F$) in kN/m ²												Durable 6 mm				
	-0.80	-0.90	-1.00	-1.10	-1.20	1.30	-1.40	-1.50	-1.60	-1.70	-1.80	-1.90	2.00	-2.10	2.20	-2.30	
400	300	300	300	300	300	300	300	300	300	300	-	-	-	-	-	-	
300	300	300	300	300	300	300	300	300	300	300	300	300	3300	300	300	300	300

Maximum fixing distance (mm) nails a (length 32 mm) for different c.t.c. distances (b) of the vertical sub-construction (k_{mod} : 1.10)

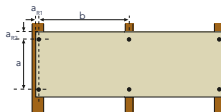

b (mm)	Design wind load on Rockpanel board ($F_d = F_{rep} * \gamma_F$) in kN/m ²												Durable 6 mm			
	-0.80	-0.90	-1.00	-1.10	-1.20	1.30	-1.40	-1.50	-1.60	-1.70	-1.80	-1.90	2.00	-2.10	2.20	-2.30
400	300	300	300	300	300	300	300	300	290	265	-	-	-	-	-	-
300	300	300	300	300	300	300	300	300	300	300	300	300	300	295	280	260

Calculation examples: fixing distances Durable

Coated Rockpanel Durable boards, 8 mm thickness
Determining the fixing distances (screw, nail, rivet):

- ETA-07/0141
- Cavity closers (on the corners of the building)
- Maximum deflection of the panels 0.75 %
- Thickness gasket max. 0.5 mm
- Quality timber battens: \geq C18, service class 2 according EN 1995-1-1
- Nail length 32 mm
- $a_{R1} \geq 15$ mm
- $a_{R2} \geq 50$ mm
- If the table shows no fixing distance (-) or building height > 10 m, please contact Rockpanel for the possibilities and specific advice.
- Not applicable for Rockpanel Natural.

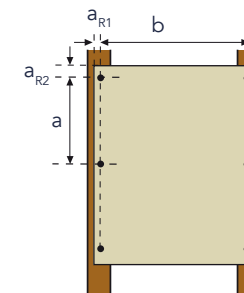

Edge distance a_{R1} (board thickness \leq 8 mm) : 15 mm
(board thickness \geq 9 mm) : 20 mm
Edge distance $a_{R2} \geq 50$ mm

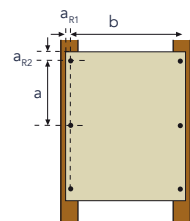

Maximum fixing distance (mm) screws a for different c.t.c. distances (b) of the vertical sub-construction (k_{mod} : 0,90 / 1,00 / 1,10)

b (mm)	Design wind load on Rockpanel board ($F_d = F_{rep} * \gamma_F$) in kN/m ²												Durable 8 mm			
	-0.80	-0.90	-1.00	-1.10	-1.20	1.30	-1.40	-1.50	-1.60	-1.70	-1.80	-1.90	2.00	-2.10	2.20	-2.30
600	-	-	-	-	-	-	-	-	-	-	-	-	-	-	-	-
500	600	600	600	600	-	-	-	-	-	-	-	-	-	-	-	-
400	600	600	600	600	600	600	580	570	560	540	540	530	480	455	435	415
300	600	600	600	600	600	600	580	570	560	540	540	530	520	510	500	490

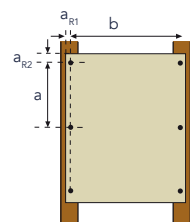

Maximum fixing distance (mm) nails a (length 32 mm) for different c.t.c. distances (b) of the vertical sub-construction (k_{mod} : 1.10)

b (mm)	Design wind load on Rockpanel board ($F_d = F_{rep} * \gamma_F$) in kN/m ²												Durable 8 mm			
	-0.80	-0.90	-1.00	-1.10	-1.20	1.30	-1.40	-1.50	-1.60	-1.70	-1.80	-1.90	2.00	-2.10	2.20	-2.30
600	-	-	-	-	-	-	-	-	-	-	-	-	-	-	-	-
500	400	400	400	400	-	-	-	-	-	-	-	-	-	-	-	-
400	400	400	400	400	400	400	400	375	355	330	315	295	280	270	255	245
300	400	400	400	400	400	400	400	400	400	400	400	390	365	355	340	325

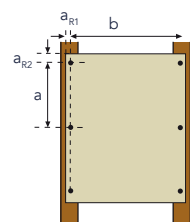

Maximum fixing distance (mm) rivets a for different c.t.c. distances (b) of the vertical sub-construction

b (mm)	Design wind load on Rockpanel board ($F_d = F_{rep} * \gamma_F$) in kN/m ²												Durable 8 mm			
	-0.80	-0.90	-1.00	-1.10	-1.20	1.30	-1.40	-1.50	-1.60	-1.70	-1.80	-1.90	2.00	-2.10	2.20	-2.30
600	-	-	-	-	-	-	-	-	-	-	-	-	-	-	-	-
500	600	600	600	600	-	-	-	-	-	-	-	-	-	-	-	-
400	600	600	600	600	600	600	580	570	560	540	540	530	520	510	500	490
300	600	600	600	600	600	600	580	580	560	540	540	530	520	510	500	490

Coated Rockpanel Durable boards, 6 mm thickness
Determining the fixing distances (screw, nail):

- ETA-08/0343
- Cavity closers (on the corners of the building)
- Maximum deflection of the panels 0.75 %
- Thickness gasket max. 0.5 mm
- Quality timber battens: \geq C18, service class 2 according EN 1995-1-1
- Nail length 32 mm
- $a_{R1} \geq 15$ mm
- $a_{R2} \geq 50$ mm
- If the table shows no fixing distance (-) or building height > 10 m, please contact Rockpanel for the possibilities and specific advice.

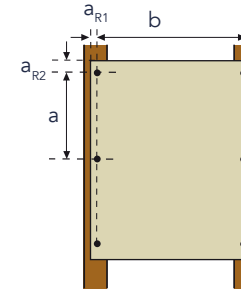

Edge distance a_{R1} (board thickness ≤ 8 mm) : 15 mm
(board thickness ≥ 9 mm) : 20 mm
Edge distance $a_{R2} \geq 50$ mm

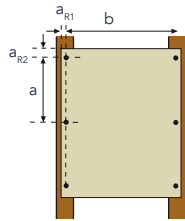

Maximum fixing distance (mm) screws a for different c.t.c. distances (b) of the vertical sub-construction (k_{mod} : 0,90 / 1,00 / 1,10)

b (mm)	Design wind load on Rockpanel board ($F_d = F_{rep} * \gamma_F$) in kN/m ²												Durable 6 mm			
	-0.80	-0.90	-1.00	-1.10	-1.20	1.30	-1.40	-1.50	-1.60	-1.70	-1.80	-1.90	2.00	-2.10	2.20	-2.30
400	300	300	-	-	-	-	-	-	-	-	-	-	-	-	-	-
300	300	300	300	300	300	300	300	300	300	300	300	3300	300	300	300	300

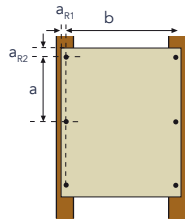

Maximum fixing distance (mm) nails a (length 32 mm) for different c.t.c. distances (b) of the vertical sub-construction (k_{mod} : 1.10)

b (mm)	Design wind load on Rockpanel board ($F_d = F_{rep} * \gamma_F$) in kN/m ²												Durable 6 mm			
	-0.80	-0.90	-1.00	-1.10	-1.20	1.30	-1.40	-1.50	-1.60	-1.70	-1.80	-1.90	2.00	-2.10	2.20	-2.30
400	300	300	-	-	-	-	-	-	-	-	-	-	-	-	-	-
300	300	300	300	300	300	300	300	300	300	300	300	300	300	300	300	300

Calculation examples: fixing distances Durable

Coated Rockpanel Durable boards, 8 mm thickness
Determining the fixing distances (screw, nail, rivet):

- ETA-07/0141
- Cavity closers (on the corners of the building)
- Maximum deflection of the panels 0.75 %
- Thickness gasket max. 0.5 mm
- Quality timber battens: \geq C18, service class 2 according EN 1995-1-1
- Nail length 32 mm
- $a_{R1} \geq 15$ mm
- $a_{R2} \geq 50$ mm
- If the table shows no fixing distance (-) or building height > 10 m, please contact Rockpanel for the possibilities and specific advice.
- Not applicable for Rockpanel Natural.

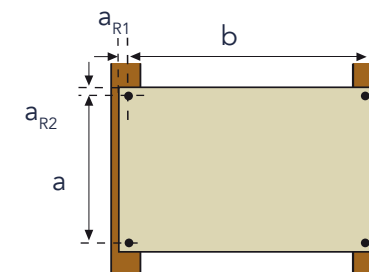

Edge distance a_{R1} (board thickness \leq 8 mm) : 15 mm
(board thickness \geq 9 mm) : 20 mm
Edge distance $a_{R2} \geq 50$ mm

Maximum fixing distance (mm) screws a for different c.t.c. distances (b) of the vertical sub-construction (k_{mod} : 0,90 / 1,00 / 1,10)

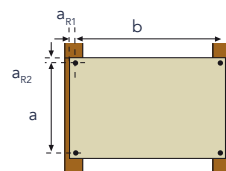

b (mm)	Design wind load on Rockpanel board ($F_d = F_{rep} * \gamma_F$) in kN/m ²												Durable 8 mm			
	-0.80	-0.90	-1.00	-1.10	-1.20	1.30	-1.40	-1.50	-1.60	-1.70	-1.80	-1.90	2.00	-2.10	2.20	-2.30
600	-	-	-	-	-	-	-	-	-	-	-	-	-	-	-	-
500	570	545	525	510	-	-	-	-	-	-	-	-	-	-	-	-
400	570	545	525	510	495	480	470	460	450	440	430	420	420	410	400	400
300	570	545	525	510	495	480	470	460	450	440	430	420	420	410	400	400

Maximum fixing distance (mm) nails a (length 32 mm) for different c.t.c. distances (b) of the vertical sub-construction (k_{mod} : 1.10)

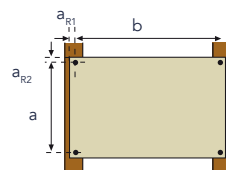

b (mm)	Design wind load on Rockpanel board ($F_d = F_{rep} * \gamma_F$) in kN/m ²												Durable 8 mm			
	-0.80	-0.90	-1.00	-1.10	-1.20	1.30	-1.40	-1.50	-1.60	-1.70	-1.80	-1.90	2.00	-2.10	2.20	-2.30
600	-	-	-	-	-	-	-	-	-	-	-	-	-	-	-	-
500	400	400	400	400	-	-	-	-	-	-	-	-	-	-	-	-
400	400	400	400	400	400	400	400	400	400	400	400	400	400	400	400	400
300	400	400	400	400	400	400	400	400	400	400	400	400	400	400	400	400

Maximum fixing distance (mm) rivets a for different c.t.c. distances (b) of the vertical sub-construction

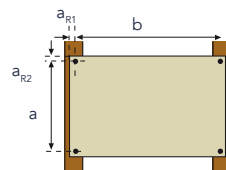

b (mm)	Design wind load on Rockpanel board ($F_d = F_{rep} * \gamma_F$) in kN/m ²												Durable 8 mm			
	-0.80	-0.90	-1.00	-1.10	-1.20	1.30	-1.40	-1.50	-1.60	-1.70	-1.80	-1.90	2.00	-2.10	2.20	-2.30
600	-	-	-	-	-	-	-	-	-	-	-	-	-	-	-	-
500	570	545	525	510	-	-	-	-	-	-	-	-	-	-	-	-
400	570	545	525	510	495	480	470	460	450	440	435	425	420	410	400	400
300	570	545	525	510	495	480	470	460	450	440	435	425	420	410	400	400

Coated Rockpanel Durable boards, 6 mm thickness
 Determining the fixing distances (screw, nail):

- ETA-08/0343
- Cavity closers (on the corners of the building)
- Maximum deflection of the panels 0.75 %
- Thickness gasket max. 0.5 mm
- Quality timber battens: \geq C18, service class 2 according EN 1995-1-1
- Nail length 32 mm
- $a_{R1} \geq 15$ mm
- $a_{R2} \geq 50$ mm
- If the table shows no fixing distance (-) or building height > 10 m, please contact Rockpanel for the possibilities and specific advice.

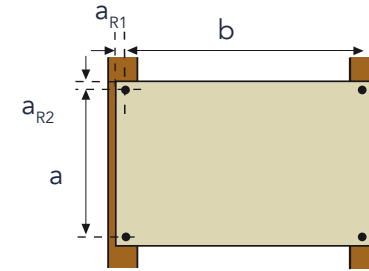

Edge distance a_{R1} (board thickness ≤ 8 mm) : 15 mm
 (board thickness ≥ 9 mm) : 20 mm
 Edge distance $a_{R2} \geq 50$ mm

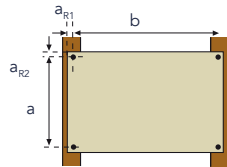

Maximum fixing distance (mm) screws a for different c.t.c. distances (b) of the vertical sub-construction (k_{mod} : 0,90 / 1,00 / 1,10)

b (mm)	Design wind load on Rockpanel board ($F_d = F_{rep} * \gamma_F$) in kN/m ²												Durable 6 mm				
	-0.80	-0.90	-1.00	-1.10	-1.20	1.30	-1.40	-1.50	-1.60	-1.70	-1.80	-1.90	2.00	-2.10	2.20	-2.30	
400	300	300	-	-	-	-	-	-	-	-	-	-	-	-	-	-	-
300	300	300	300	300	300	300	300	300	300	300	300	300	3300	300	300	300	300

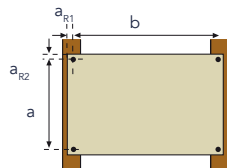

Maximum fixing distance (mm) nails a (length 32 mm) for different c.t.c. distances (b) of the vertical sub-construction (k_{mod} : 1,10)

b (mm)	Design wind load on Rockpanel board ($F_d = F_{rep} * \gamma_F$) in kN/m ²												Durable 6 mm				
	-0.80	-0.90	-1.00	-1.10	-1.20	1.30	-1.40	-1.50	-1.60	-1.70	-1.80	-1.90	2.00	-2.10	2.20	-2.30	
400	300	300	-	-	-	-	-	-	-	-	-	-	-	-	-	-	-
300	300	300	300	300	300	300	300	300	300	300	300	300	300	300	300	300	300

Calculation examples: fixing distances Uni

Coated Rockpanel Uni boards, 6 mm thickness
Determining the fixing distances (screw, nail):

- ETA-17/0619
- Cavity closers (on the corners of the building)
- Maximum deflection of the panels 0.75 %
- Thickness gasket max. 0.5 mm
- Quality timber battens: \geq C18, service class 2 according EN 1995-1-1
- Nail length 32 mm
- $a_{R1} \geq 15$ mm
- $a_{R2} \geq 50$ mm
- If the table shows no fixing distance (-) or building height > 10 m, please contact Rockpanel for the possibilities and specific advice.

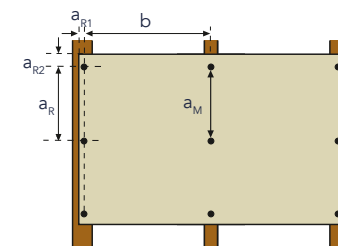

Edge distance a_{R1} (board thickness ≤ 8 mm) : 15 mm
(board thickness ≥ 9 mm) : 20 mm
Edge distance $a_{R2} \geq 50$ mm

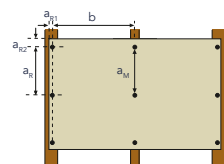

Maximum fixing distance (mm) screws a_M for different c.t.c. distances (b) of the vertical sub-structure (k_{mod} : 0,90 / 1,00 / 1,10)

b (mm)	Design wind load on Rockpanel board ($F_d = F_{rep} * \gamma_F$) in kN/m ²												Uni 6 mm			
	-0.80	-0.90	-1.00	-1.10	-1.20	1.30	-1.40	-1.50	-1.60	-1.70	-1.80	-1.90	2.00	-2.10	2.20	-2.30
400	300	300	300	300	300	300	300	300	295	-	-	-	-	-	-	-
300	300	300	300	300	300	300	300	300	295	300	260	245	235	225	215	205

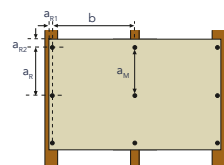

Maximum fixing distance (mm) nails a_M (length 32 mm) for different c.t.c. distances (b) of the vertical sub-structure (k_{mod} : 1,10)

b (mm)	Design wind load on Rockpanel board ($F_d = F_{rep} * \gamma_F$) in kN/m ²												Uni 6 mm			
	-0.80	-0.90	-1.00	-1.10	-1.20	1.30	-1.40	-1.50	-1.60	-1.70	-1.80	-1.90	2.00	-2.10	2.20	-2.30
400	300	300	290	265	240	225	205	195	180	-	-	-	-	-	-	-
300	300	300	290	265	240	225	205	195	180	170	160	150	145	135	130	125

Coated Rockpanel Uni boards, 6 mm thickness
 Determining the fixing distances (screw, nail):

- ETA-17/0619
- Cavity closers (on the corners of the building)
- Maximum deflection of the panels 0.75 %
- Thickness gasket max. 0.5 mm
- Quality timber battens: \geq C18, service class 2 according EN 1995-1-1
- Nail length 32 mm
- $a_{R1} \geq 15$ mm
- $a_{R2} \geq 50$ mm
- If the table shows no fixing distance (-) or building height > 10 m, please contact Rockpanel for the possibilities and specific advice.

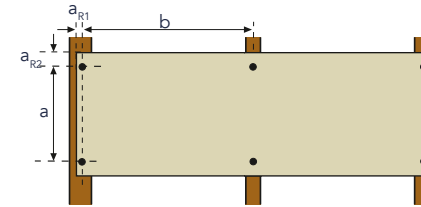

Edge distance a_{R1} (board thickness ≤ 8 mm) : 15 mm
 (board thickness ≥ 9 mm) : 20 mm
 Edge distance $a_{R2} \geq 50$ mm

Maximum fixing distance (mm) screws a for different c.t.c. distances (b) of the vertical sub-construction (k_{mod} : 0,90 / 1,00 / 1,10)

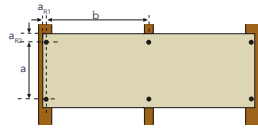

b (mm)	Design wind load on Rockpanel board ($F_d = F_{rep} * \gamma_F$) in kN/m ²												Uni 6 mm			
	-0.80	-0.90	-1.00	-1.10	-1.20	1.30	-1.40	-1.50	-1.60	-1.70	-1.80	-1.90	2.00	-2.10	2.20	-2.30
400	300	300	300	300	300	300	300	300	300	-	-	-	-	-	-	-
300	300	300	300	300	300	300	300	300	300	275	255	235	220	205	-	-

Maximum fixing distance (mm) nails a (length 32 mm) for different c.t.c. distances (b) of the vertical sub-construction (k_{mod} : 1.10)

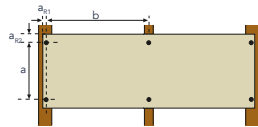

b (mm)	Design wind load on Rockpanel board ($F_d = F_{rep} * \gamma_F$) in kN/m ²												Uni 6 mm			
	-0.80	-0.90	-1.00	-1.10	-1.20	1.30	-1.40	-1.50	-1.60	-1.70	-1.80	-1.90	2.00	-2.10	2.20	-2.30
400	300	300	300	300	300	300	295	270	245	-	-	-	-	-	-	-
300	300	300	300	300	300	300	295	270	245	225	210	190	175	165	-	-

Calculation examples: fixing distances Uni

Coated Rockpanel Uni boards, 6 mm thickness
Determining the fixing distances (screw, nail):

- ETA-17/0619
- Cavity closers (on the corners of the building)
- Maximum deflection of the panels 0.75 %
- Thickness gasket max. 0.5 mm
- Quality timber battens: \geq C18, service class 2 according EN 1995-1-1
- Nail length 32 mm
- $a_{R1} \geq 15$ mm
- $a_{R2} \geq 50$ mm
- If the table shows no fixing distance (-) or building height > 10 m, please contact Rockpanel for the possibilities and specific advice.

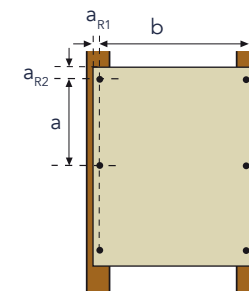

Edge distance a_{R1} (board thickness ≤ 8 mm) : 15 mm
(board thickness ≥ 9 mm) : 20 mm
Edge distance $a_{R2} \geq 50$ mm

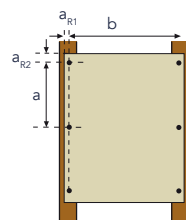

Maximum fixing distance (mm) screws a for different c.t.c. distances (b) of the vertical sub-struction (k_{mod} : 0,90 / 1,00 / 1,10)

b (mm)	Design wind load on Rockpanel board ($F_d = F_{rep} * \gamma_F$) in kN/m ²												Uni 6 mm				
	-0.80	-0.90	-1.00	-1.10	-1.20	1.30	-1.40	-1.50	-1.60	-1.70	-1.80	-1.90	2.00	-2.10	2.20	-2.30	
400	300	-	-	-	-	-	-	-	-	-	-	-	-	-	-	-	-
300	300	300	300	300	300	300	300	300	300	300	300	300	300	300	300	300	300

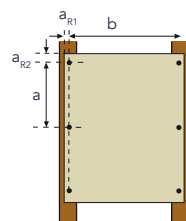

Maximum fixing distance (mm) nails a (length 32 mm) for different c.t.c. distances (b) of the vertical sub-struction (k_{mod} : 1.10)

b (mm)	Design wind load on Rockpanel board ($F_d = F_{rep} * \gamma_F$) in kN/m ²												Uni 6 mm				
	-0.80	-0.90	-1.00	-1.10	-1.20	1.30	-1.40	-1.50	-1.60	-1.70	-1.80	-1.90	2.00	-2.10	2.20	-2.30	
400	300	-	-	-	-	-	-	-	-	-	-	-	-	-	-	-	-
300	300	300	300	300	300	300	300	300	300	300	300	300	300	300	300	300	300

Coated Rockpanel Uni boards, 6 mm thickness
 Determining the fixing distances (screw, nail):

- ETA-17/0619
- Cavity closers (on the corners of the building)
- Maximum deflection of the panels 0.75 %
- Thickness gasket max. 0.5 mm
- Quality timber battens: \geq C18, service class 2 according EN 1995-1-1
- Nail length 32 mm
- $a_{R1} \geq 15$ mm
- $a_{R2} \geq 50$ mm
- If the table shows no fixing distance (-) or building height > 10 m, please contact Rockpanel for the possibilities and specific advice.

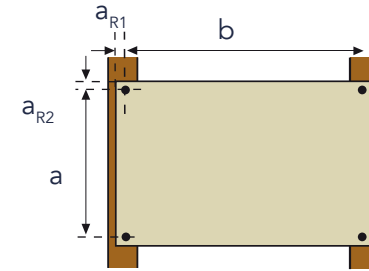

Edge distance a_{R1} (board thickness ≤ 8 mm) : 15 mm
 (board thickness ≥ 9 mm) : 20 mm
 Edge distance $a_{R2} \geq 50$ mm

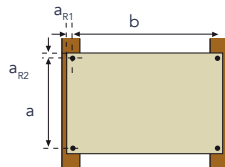

Maximum fixing distance (mm) screws a for different c.t.c. distances (b) of the vertical sub-construction (k_{mod} : 0,90 / 1,00 / 1,10)

b (mm)	Design wind load on Rockpanel board ($F_d = F_{rep} * \gamma_F$) in kN/m ²												Uni 6 mm				
	-0.80	-0.90	-1.00	-1.10	-1.20	1.30	-1.40	-1.50	-1.60	-1.70	-1.80	-1.90	2.00	-2.10	2.20	-2.30	
400	300	-	-	-	-	-	-	-	-	-	-	-	-	-	-	-	-
300	300	300	300	300	300	300	300	300	300	300	300	300	300	295	290	285	

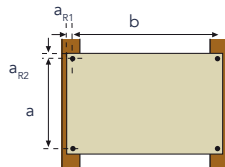

Maximum fixing distance (mm) nails a (length 32 mm) for different c.t.c. distances (b) of the vertical sub-construction (k_{mod} : 1,10)

b (mm)	Design wind load on Rockpanel board ($F_d = F_{rep} * \gamma_F$) in kN/m ²												Uni 6 mm				
	-0.80	-0.90	-1.00	-1.10	-1.20	1.30	-1.40	-1.50	-1.60	-1.70	-1.80	-1.90	2.00	-2.10	2.20	-2.30	
400	300	-	-	-	-	-	-	-	-	-	-	-	-	-	-	-	-
300	300	300	300	300	300	300	300	300	300	300	300	300	300	295	290	285	

Calculation examples: fixing distances Lines²

Tongue and groove cladding boards

Maximum fixing distances for Rockpanel Lines² on a timber sub-construction
Rockpanel Lines² 10 mm

- Location in country
- Distance from coast > 10 km
- Site altitude ≤ 50 m
- Strength class timber sub-construction C24 according EN338
- Aluminium sub-construction according ETA
- $a_{R1} \geq 15$ mm, $a_{R2} = 15$, $a_{R3} \geq 20$ mm

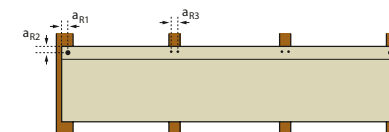

Maximum permissible building height (m) Lines² 10 mm with a 2-field span, fixed using a double Rockpanel ring shank nail, 2,1/2,3 x 27 mm at the intermediate battens.

Basic wind velocity	Span c.t.c. (mm)	Lines ² 10 XL		Lines ² 10 S	
		Zone B: Middle area	Zone A: Corner area	Zone B: Middle area	Zone A: Corner area
22 m/s	600	30	10	30*	30*
	500	30*	20	30*	30*
23 m/s	600	20	7	30*	30
	500	30*	15	30*	30*
24 m/s	600	15	7	30*	20
	500	30	15	30*	30*
25 m/s	600	10	5	30*	15
	500	20	10	30*	30*
26 m/s	600	7	-	30	10
	500	15	7	30*	30*

- If the table shows no fixing distance (-), contact Rockpanel for the possibilities and specific advice.
 - For applications < 10 km from the coast, also at higher site altitudes and higher wind speeds, Rockpanel should be consulted.
 - The specification of the Rockpanel screw and rivet should be in accordance with the appropriate ETA.
- * Higher buildings not calculated. Contact Rockpanel for advice

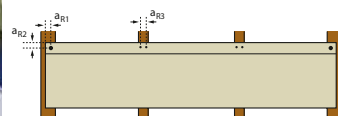

Tongue and groove cladding boards

Maximum fixing distances for Rockpanel Lines² on a timber sub-construction
Rockpanel Lines² 10 mm

- Location in country
- Distance from coast > 10 km
- Site altitude ≤ 50 m
- Strength class timber sub-construction C24 according EN338
- Aluminium sub-construction according ETA
- $a_{R1} \geq 15$ mm, $a_{R2} = 15$, $a_{R3} \geq 20$ mm

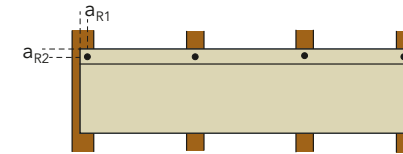

Maximum permissible building height (m) Lines² 10 mm with a 2-field span, fixed using a single Rockpanel ring shank nail, 2,1/2,3 x 27 mm at the intermediate battens.

Basic wind velocity	Span c.t.c. (mm)	Lines ² 10 XL		Lines ² 10 S	
		Zone B: Middle area	Zone A: Corner area	Zone B: Middle area	Zone A: Corner area
22 m/s	600	-	-	30	10
	500	5	-	30*	20
23 m/s	600	-	-	20	7
	500	-	-	30*	15
24 m/s	600	-	-	15	5
	500	-	-	30	10
25 m/s	600	-	-	10	-
	500	-	-	20	7
26 m/s	600	-	-	7	-
	500	-	-	15	5

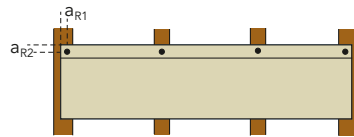

- If the table shows no fixing distance (-), contact Rockpanel for the possibilities and specific advice.
 - For applications < 10 km from the coast, also at higher site altitudes and higher wind speeds, Rockpanel should be consulted.
 - The specification of the Rockpanel screw and rivet should be in accordance with the appropriate ETA.
- * Higher buildings not calculated. Contact Rockpanel for advice

Board joints, corner solutions and bending

Board joints

- Rockpanel is dimensionally stable, and therefore resistant to changes in length and width arising from variations in temperature and humidity.
- Take into account that boards, installation and building tolerances play an important role in the detailing of joints.
- Apply weather- and UV-resistant EPDM gasket behind the joints to protect the sub-construction against weather influences.
- The joints should be equal to or bigger than 5 mm, to ensure proper drainage.
- See paragraph 'ventilated constructions' on page 104-106 for horizontal and vertical board connections and the 'fixing guidelines' subsection on pages 118-120 for the opportunities for wind reduction with open joints.
- In horizontal use of Rockpanel Lines², horizontal seams are automatically covered by the overlaid board and no additional finishing of the seam is necessary, on vertical framework, weather resistant joint tape should be applied to protect the framework. Rockpanel recommends that a joint width of at least 3 mm should be maintained between the boards.

Corner solutions

Finishing the edges is only necessary to meet any design or aesthetic requirements. Rockpanel offers a range of solutions for an attractive finish at corners and edges.

Assembly corner joint with natural dark brown edges

Without finishing, the basic material changes colour to natural dark brown under the effect of UV.

Corner profiles in a RAL/NCS colour

A solution with a corner profile in a compatible RAL colour ensures a perfect finish.

See page 91 for a complete overview of the profiles.

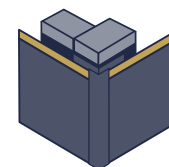
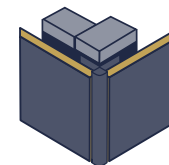

Mitre joint

For the highly skilled installer, a mitre joint can be achieved with the material, thereby creating a precise and uniform finish.

Important: the minimum panel thickness for this solution is 8 mm.

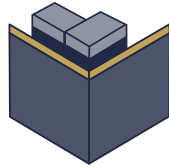

Edge paint

Finishing the edges with matching colour paint is another option.

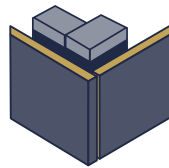

Bending and curving

Rockpanel boards can easily be bent and curved without any treatment. This allows even more design possibilities for creating beautiful facade finishes. The advised minimum bending radius is determined by the bending strength of the Rockpanel boards, assuming that the board is bent lengthwise. The following values only apply for Durable and A2.



Rockpanel Colours, Metals, Woods, Stones & Chameleon

Panel thickness (mm)	Durable 6	Durable 8	A2 9
Panel length (curve, mm)	3050	3050	3050
Radius R minimal (mm)	1900	2500	3600
Corner α	91.97°	69.9°	48.54°
Chord (mm)	2733	2864	2959
Level (mm)	580	451	318
Battens c.t.c. (mm)	300	400	**
Fixings c.t.c. (mm)*	250	300	**

* Indication for the fixing distances in urban and rural environments with building heights ≤ 10 m. When Rockpanel is applied in bent or curved conditions on higher buildings or in environments with a higher wind load, please contact Rockpanel.

** For fixing distances of bended A2 boards, please contact Rockpanel.

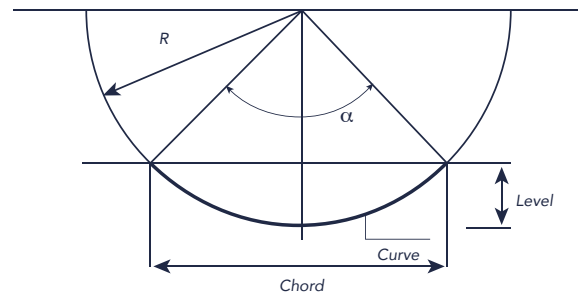

Guidelines seamless installation

Rockpanel board material retains its shape as it is able to withstand moisture and changes in temperature. This allows it to be used seamlessly under certain conditions:

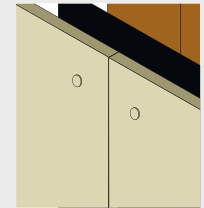

- Only for use around the roofline, such as to finish guttering, for fascias and barge boards. If you are considering another application with butt joints, contact Rockpanel for individual and expert advice;
- Up to a maximum length of 12 metres;
- Only when a timber subframe is used with vertical battens to prevent the subframe from warping;
- The timber subframe is protected by using EPDM foam gaskets for all joints on the subframe;
- Expansion joints are used throughout the Rockpanel construction. If there are expansion joints in the structure, the facade panels must also have expansion joints.
- Only applicable with light colours.

If you wish to specify an application with butt joints contact Rockpanel for an advice.

Details

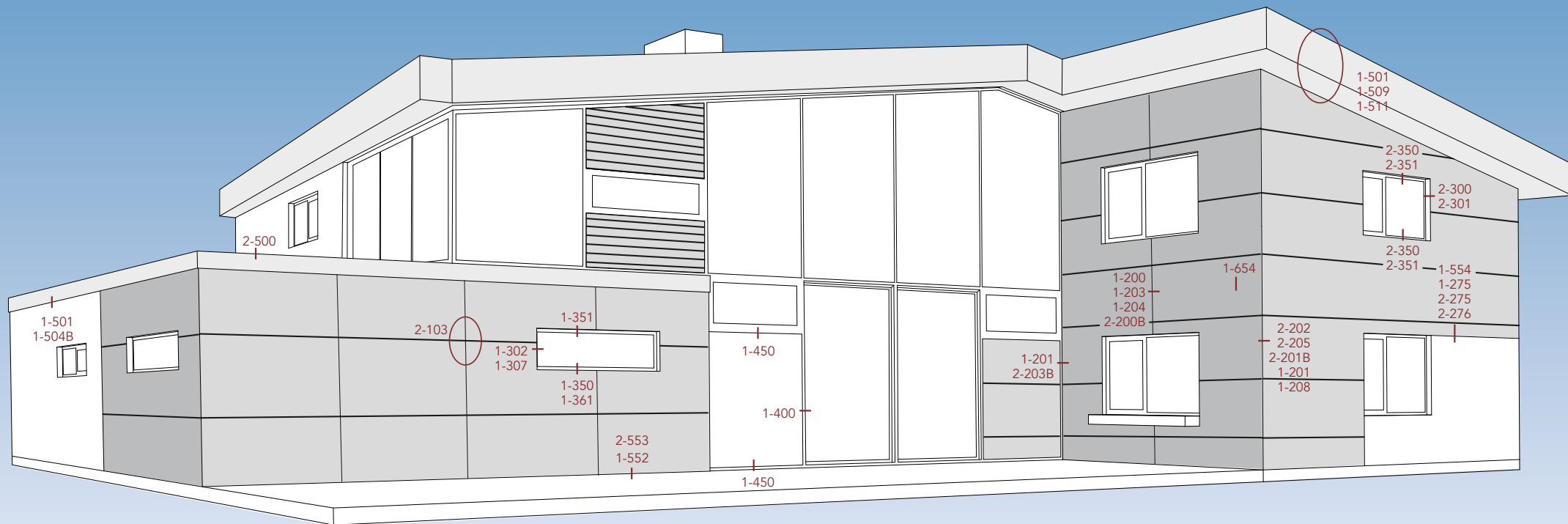

Facade

Aluminium sub-construction 138 - 144

- 2-103: mechanically fixed, principles
- 2-200B: mechanically fixed to aluminium supports, abutment vertical joint
- 2-201B: mechanically fixed to aluminium supports, external corner
- 2-203B: mechanically fixed to aluminium supports, internal corner
- 2-205: concealed fixing, external corner
- 2-300: mechanically fixed, horizontal junction to a window frame
- 2-301: mechanically fixed, horizontal junction to a window frame, finished with a metal sheet
- 2-350: mechanically fixed, vertical junction over window frame
- 2-351: vertical section over window frame with aluminium substructure with metal reveal
- 2-500: mechanically fixed, vertical cross section at flat roof
- 2-553: concealed fixing, abutting detail pavement
- 2-275: mechanical fixing – ETICS
- 2-276: mechanical fixed, junction to ETICS

Timber sub-construction 145 - 151

- 1-200: mechanically fixed to timber support, with vertical joints
- 1-201: mechanically fixed to timber support, internal and external corner
- 1-203: mechanically fixed to timber supports, vertical joints, vertical intermediate fastening using a Rockpanel strip
- 1-204: adhesive installation on timber sub-construction with Rockpanel strips
- 1-208: mechanically fixed to timber supports, with vertical external aluminium corner profile
- 1-275: mechanically fixed, junction to ETICS
- 1-302: mechanically fixed to timber supports, horizontal window-frame junction with profile
- 1-307: mechanically fixed, on timber sub-construction, horizontal cross section at window frame junction

- 1-350: mechanically fixed to timber supports, vertical junction at window-sill
- 1-351: mechanically fixed to timber supports, junction at window head
- 1-361: mechanically fixed, on timber sub-construction, vertical cross section junction at window-sill
- 1-552: mechanically fixed, connection at ground level
- 1-554: mechanically fixed, junction to a plaster wall

Sustainable construction

BRE-certified construction 152

- 1-654: Vertical cross section of a ventilated facade on a timber sub-construction

Roofline

New build 153

- 1-501: mechanically fixed, fascia board new build
- 1-509: mechanically fixed, soffit board new build

Renovation 154

- 1-504B: mechanically fixed, fascia board renovation
- 1-511: mechanically fixed, soffit board renovation

Detailing

Non-ventilated applications 155

- 1-400: mechanically fixed, non-ventilated infilling (horizontal)
- 1-450: mechanically fixed, non-ventilated infilling (vertical)

These CAD details provide basic guidelines and should be checked on relevance and accuracy when considered for actual installation.

Facade

Aluminium
sub-construction

Mechanically fixed: principles

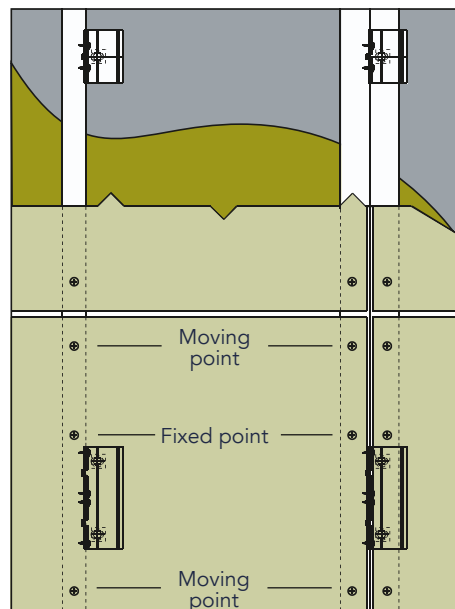

Detail 2-103

Note:

Rockpanel cannot be used unventilated with aluminium support structures.

Attention:

For aluminium constructions in an open facade Rockpanel recommends a cavity depth of 40 mm - 100 mm.

Mechanically fixed to aluminium supports, abutment vertical joint

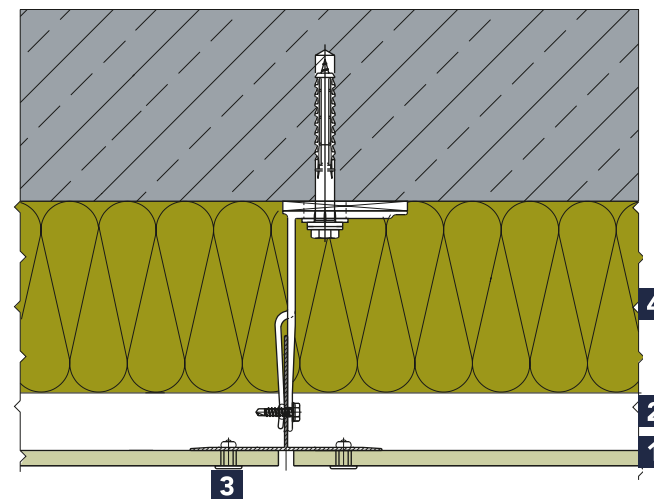

Detail 2-200B

- 1 Rockpanel \geq 8 mm
- 2 Ventilation
- 3 Rivet according to specifications
- 4 Insulation (for example ROCKWOOL)

Mechanically fixed to aluminium supports, external corner

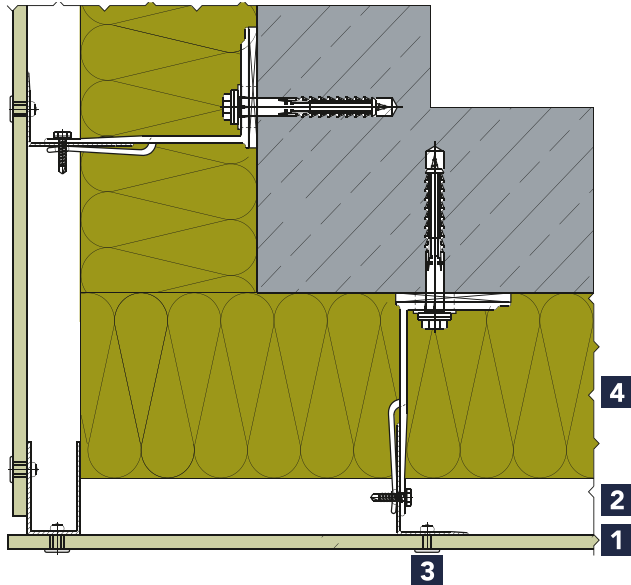

Detail 2-201B

- 1** Rockpanel ≥ 8 mm
- 2** Ventilation
- 3** Rivet according to specifications
- 4** Insulation (for example ROCKWOOL)

Mechanically fixed to aluminium supports, internal corner

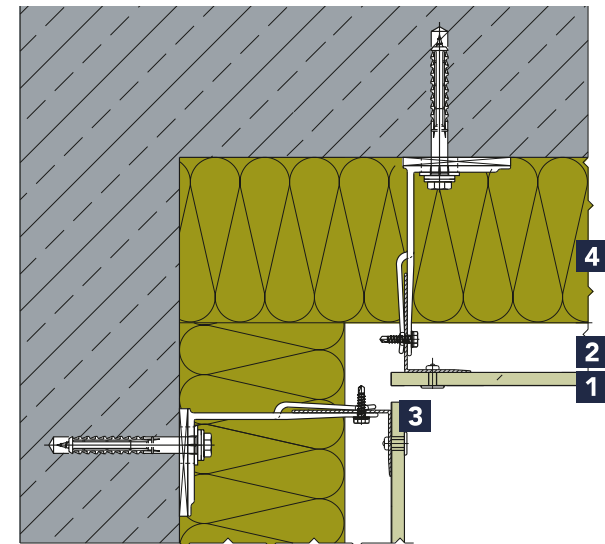

Detail 2-203B

- 1** Rockpanel ≥ 8 mm
- 2** Ventilation
- 3** Rivet according to specifications
- 4** Insulation (for example ROCKWOOL)

Facade

Aluminium
sub-construction

Concealed fixing, external corner

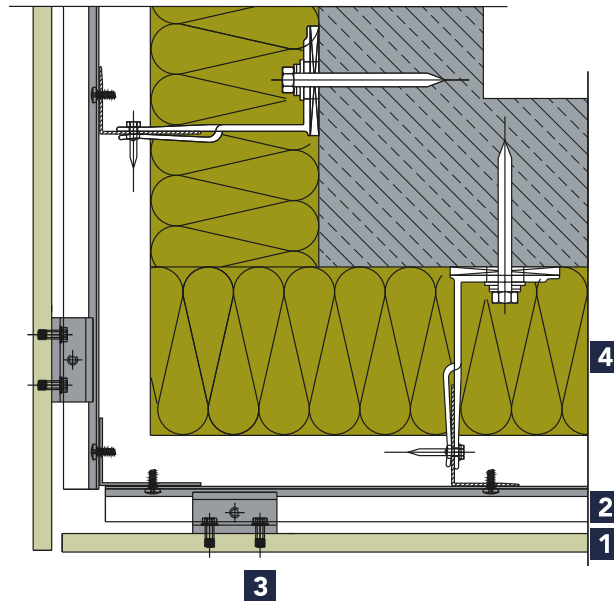

Detail 2-205

- 1** Rockpanel 11 mm
- 2** Ventilation
- 3** Concealed fixing clip according to specifications
- 4** Insulation (for example ROCKWOOL)

Mechanically fixed, horizontal junction to a window frame

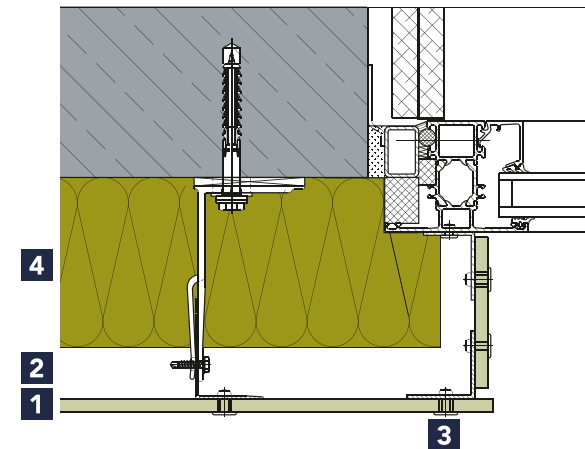

Detail 2-300

- 1** Rockpanel ≥ 8 mm
- 2** Ventilation
- 3** Rivet according to specifications
- 4** Insulation (for example ROCKWOOL)

Note:

Rockpanel cannot be used unventilated with aluminium support structures.

Attention:

For aluminium constructions in an open facade Rockpanel recommends a cavity depth of 40 mm - 100 mm.

Mechanically fixed, horizontal junction to a window frame, finished with a metal sheet

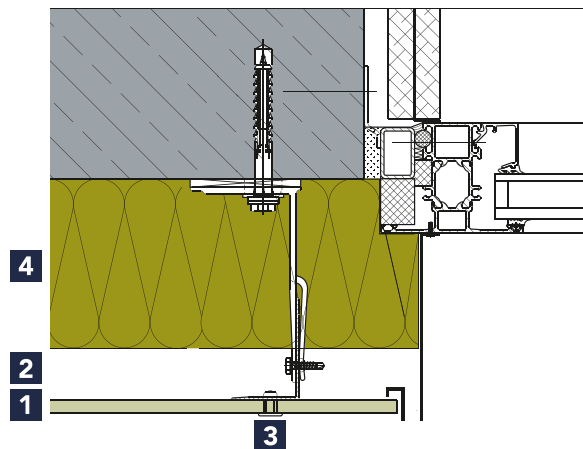

Detail 2-301

- 1** Rockpanel ≥ 8 mm
- 2** Ventilation
- 3** Rivet according to specifications
- 4** Insulation (for example ROCKWOOL)

Mechanically fixed, vertical junction over window frame

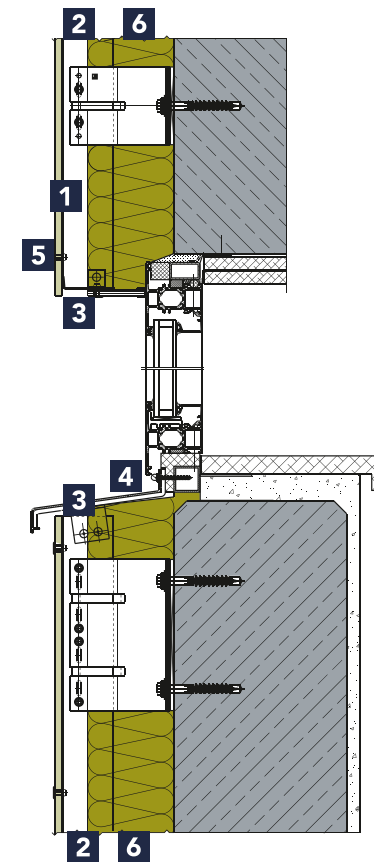

Detail 2-350

- 1** Rockpanel ≥ 8 mm
- 2** Ventilation
- 3** Ventilation profile / ventilated opening
- 4** Aluminium window-sill with bulkhead
- 5** Rivet according to specifications
- 6** Insulation (for example ROCKWOOL)

Facade

Aluminium
sub-construction

Vertical section over window frame with aluminium substructure with metal reveal

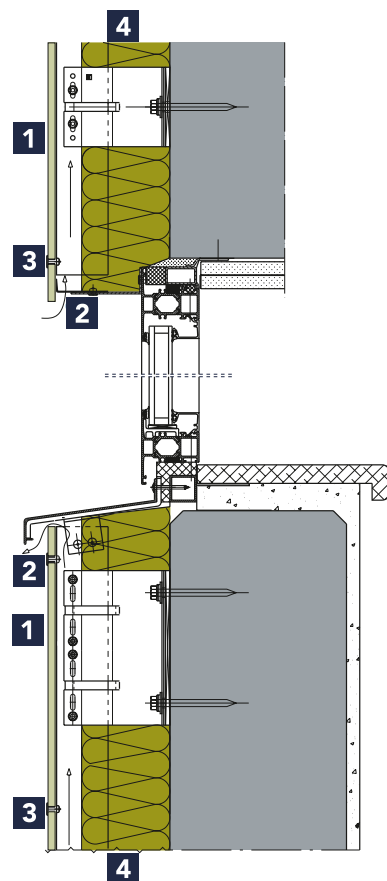

Detail 2-351

- 1** Rockpanel ≥ 8 mm
- 2** Ventilation
- 3** Rivets according to specifications
- 4** Insulation (for example ROCKWOOL)

Mechanically fixed, vertical cross section at flat roof

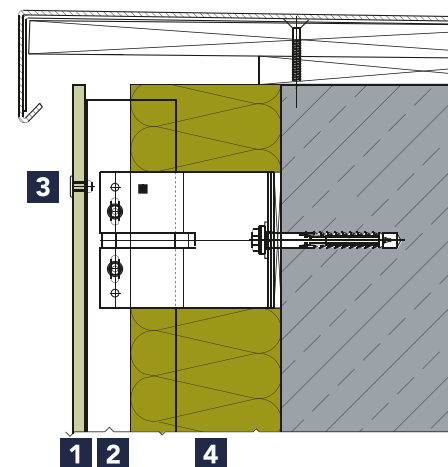

Detail 2-500

- 1** Rockpanel ≥ 8 mm
- 2** Ventilation
- 3** Rivet according to specifications
- 4** Insulation (for example ROCKWOOL)

Concealed fixing, abutting detail pavement

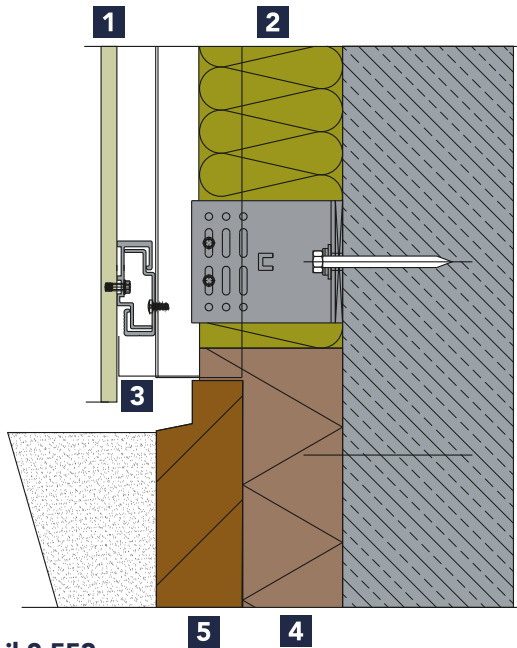

Detail 2-553

- 1** Rockpanel 11 mm
- 2** Insulation (for example ROCKWOOL)
- 3** Insect mesh
- 4** Insulation
- 5** Wall base plinth

Mechanical fixing – ETICS

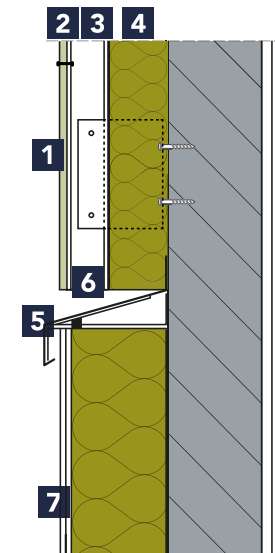

Detail 2-275

- 1** Rockpanel ≥ 8 mm
- 2** EPDM gasket
- 3** Rail support / ventilation
- 4** Insulation (for example ROCKWOOL)
- 5** Flashing
- 6** Ventilation
- 7** ETICS system according to external manufacturer

Facade

Timber
sub-construction

Mechanically fixed to timber support, with vertical joints

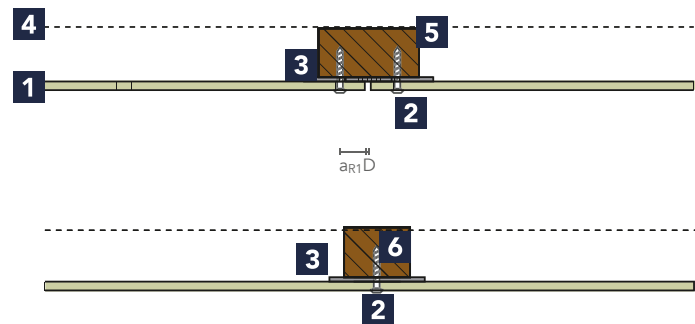

Detail 1-200

- 1** Rockpanel ≥ 6 mm
 - 2** Rockpanel screw
 - 3** EPDM gasket
 - 4** Breathable membrane
 - 5** Battens $\geq 28 \times 70$ mm
 - 6** Battens $\geq 28 \times 45$ mm
- D Assembly joint
 $a_{R1} \geq 15$ mm edge distance

Mechanically fixed to timber supports, internal and external corner

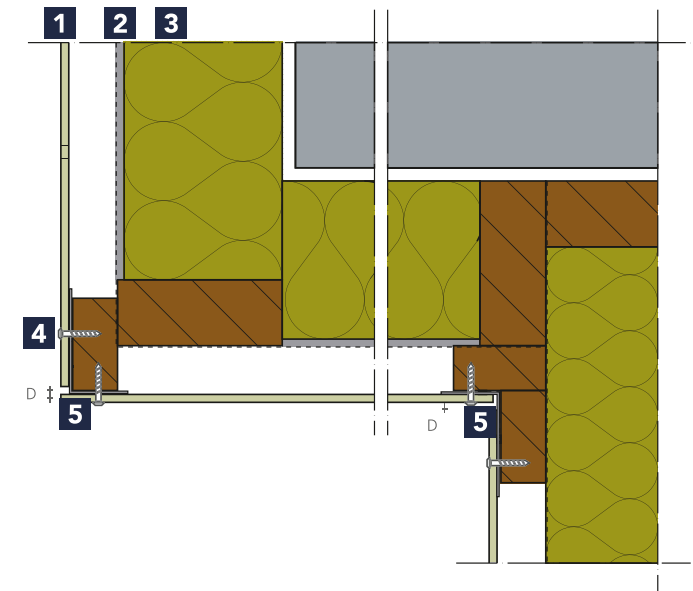

Detail 1-201

- 1** Rockpanel ≥ 6 mm
 - 2** Breathable membrane
 - 3** Insulation (for example ROCKWOOL)
 - 4** Rockpanel screw
 - 5** EPDM gasket
- D Assembly joint

Facade

Timber
sub-construction

**Mechanically fixed to timber supports,
with vertical joints with vertical interme-
diate fastening using a Rockpanel Strip**

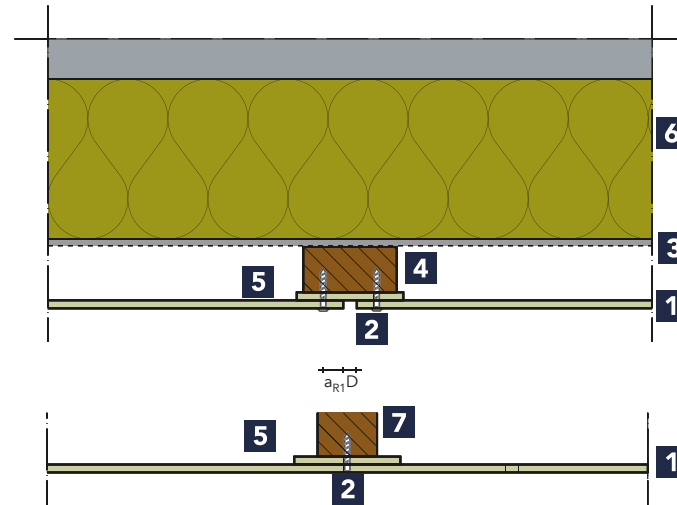

Detail 1-203

- 1** Rockpanel ≥ 6 mm
- 2** Rockpanel ring shank nail 40 mm
- 3** Breathable membrane
- 4** Battens $\geq 28 \times 70$ mm
- 5** Rockpanel Strip (Edge distance on both sides 15 mm)
- 6** Insulation (for example ROCKWOOL)
- 7** Lat $\geq 28 \times 45$ mm, D Assembly joint
 $a_{R1} \geq 15$ mm edge distance

Note: The hammer-in or screw-in depth is reduced for attachment on Rockpanel strips. Use the 40 mm nail for sufficient screw-in depth.

**Adhesive installation on timber
sub-construction with
Rockpanel strips**

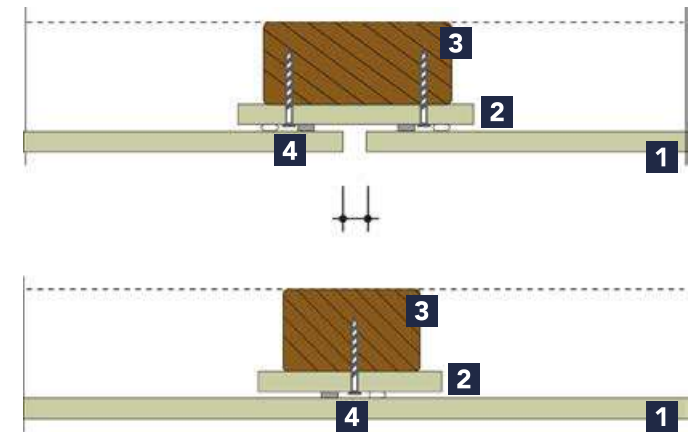

Detail 1-204

- 1** Rockpanel 8 mm
- 2** Rockpanel Tack S
- 3** Battens $\geq 28 \times 70$ mm
- 4** Rockpanel screw

**Mechanically fixed to timber supports,
with vertical external aluminium corner
profile**

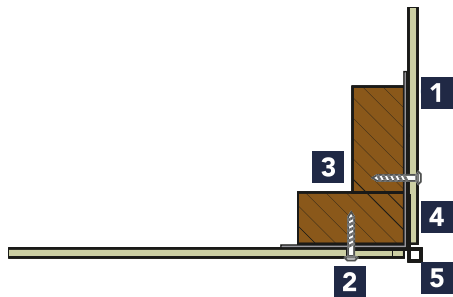

Detail 1-208

- 1** Rockpanel ≥ 6 mm
- 2** Rockpanel screw
- 3** Battens $\geq 28 \times 70$ mm
- 4** EPDM gasket
- 5** Rockpanel corner profile type D

**Mechanically fixed,
junction to ETICS**

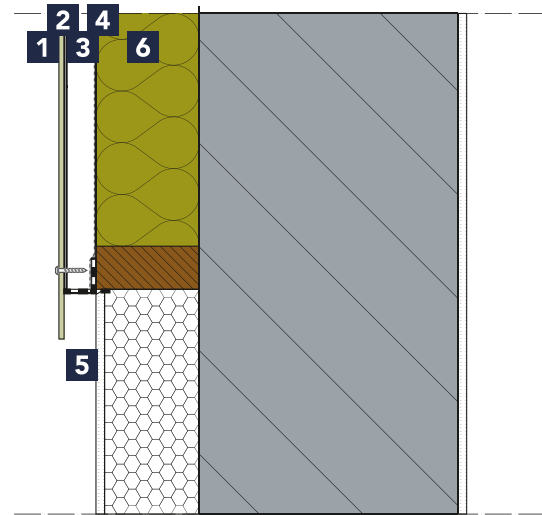

Detail 1-275

- 1** Rockpanel ≥ 8 mm
- 2** EPDM gasket
- 3** Rail support / ventilation
- 4** Breathable membrane
- 5** Ventilation profile
- 6** Insulation (for example ROCKWOOL)

Facade

Timber
sub-construction

**Mechanically fixed to timber supports,
horizontal window-frame junction
with profile**



Detail 1-302

- 1** Rockpanel ≥ 8 mm
 - 2** Wooden frame
 - 3** Breathable membrane
 - 4** Insulation
(for example ROCKWOOL)
 - 5** Clearance of prefab element
 - 6** PU foam
 - 7** EPDM gasket
 - 8** Rockpanel screw
 - 9** Profile F
- D Assembly joint
 $a_{R1} \geq 15$ mm edge distance

**Mechanically fixed, on timber
sub-construction, horizontal cross
section at window frame junction**

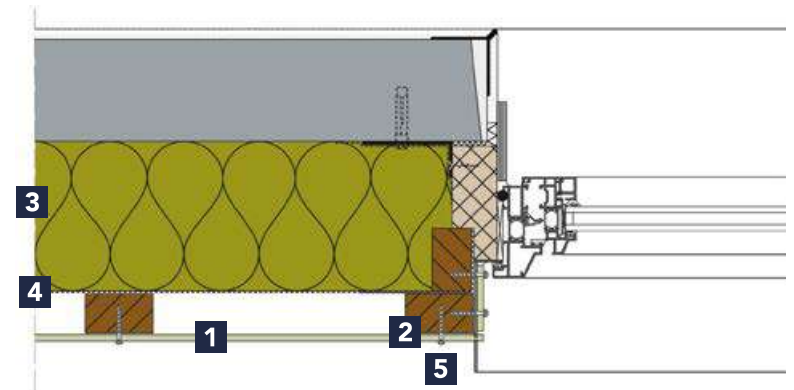

Detail 1-307

- 1** Rockpanel ≥ 8 mm
 - 2** EPDM gasket
 - 3** Insulation (for example ROCKWOOL)
 - 4** Breathable membrane
 - 5** Rockpanel screw
- D Corner profile
 $a_{R1} \geq 15$ mm edge distance

Mechanically fixed to timber supports, vertical junction at window-sill

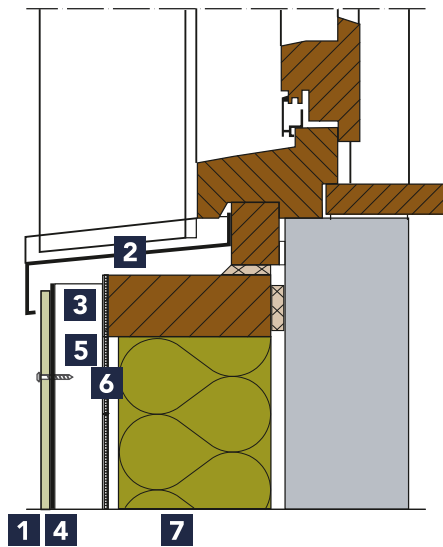

Detail 1-350

- 1** Rockpanel ≥ 8 mm
- 2** Aluminium window-sill with bulkhead
- 3** Ventilation
- 4** EPDM gasket
- 5** Battens
- 6** Breathable membrane
- 7** Insulation (for example ROCKWOOL)

Mechanically fixed to timber supports, junction at window head

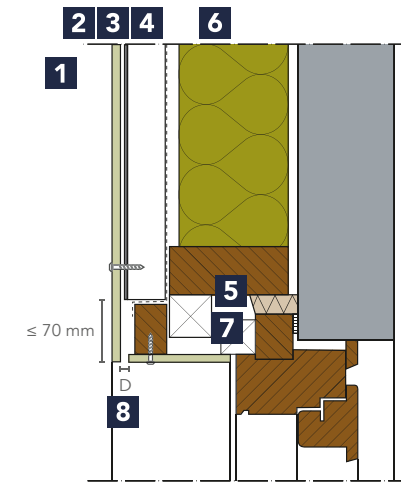

Detail 1-351

- 1** Rockpanel ≥ 8 mm
 - 2** EPDM gasket
 - 3** Battens
 - 4** Breathable membrane
 - 5** Framework
 - 6** Insulation (for example ROCKWOOL)
 - 7** PU foam
 - 8** Rockpanel ring shank nail or screw
- D Assembly joint

Facade

Timber
sub-construction

Mechanically fixed, on timber sub-construction, vertical cross section junction at window-sill

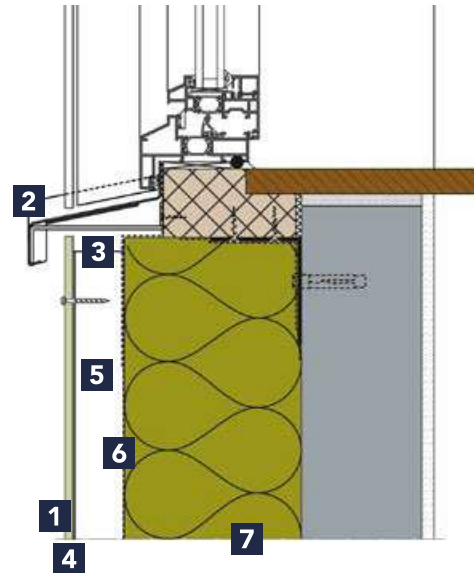

Detail 1-361

- 1** Rockpanel ≥ 8 mm
- 2** Aluminium window-sill with drip edge
- 3** Ventilation opening
- 4** EPDM gasket
- 5** Vertical battens
- 6** Breathable membrane
- 7** Insulation (for example ROCKWOOL)

Mechanically fixed, connection at ground level

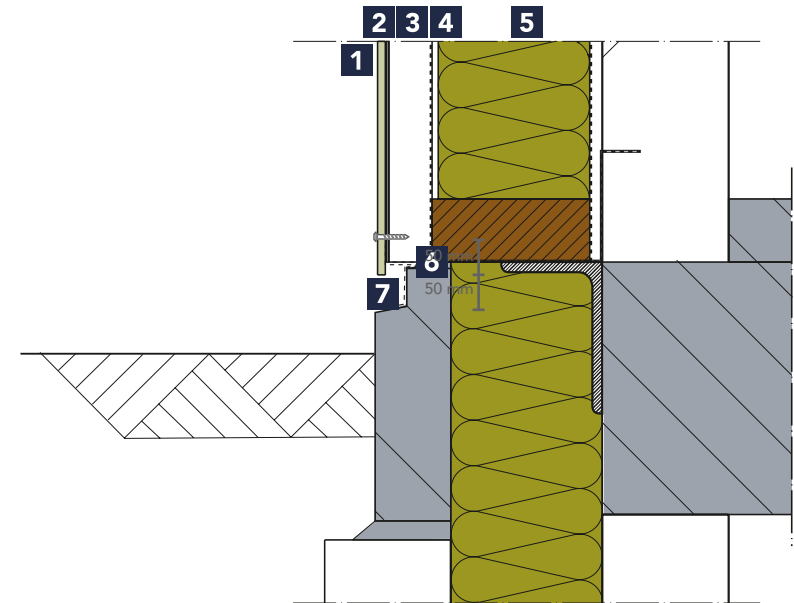

Detail 1-552

- 1** Rockpanel ≥ 8 mm
- 2** EPDM gasket
- 3** Battens / ventilation
- 4** Breathable membrane
- 5** Insulation (for example ROCKWOOL)
- 6** Flashing / cavity tray
- 7** Ventilation profile

Mechanically fixed, junction to a plaster wall

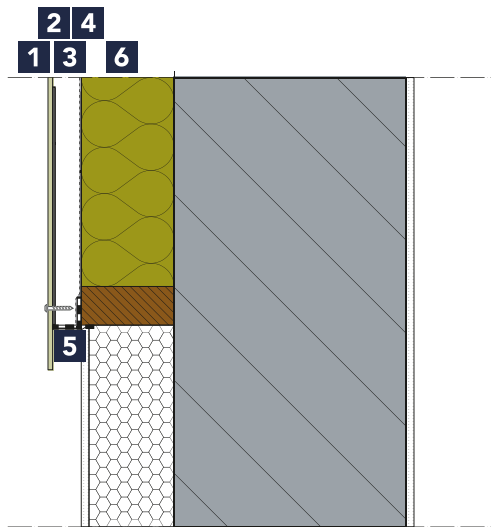

Detail 1-554

- 1** Rockpanel ≥ 8 mm
- 2** EPDM gasket
- 3** Battens / ventilation
- 4** Breathable membrane
- 5** Ventilation profile
- 6** Insulation (for example ROCKWOOL)

Sustainable construction

BRE certified construction



The detail given above is 1 of the 16 BRE certified constructions with Rockpanel cladding material based on Certificate of Approval Environmental Profiles No: ENP 427. Contact Rockpanel for more information and other BRE certified CAD drawings.

Vertical cross section of a ventilated facade on a timber sub-construction

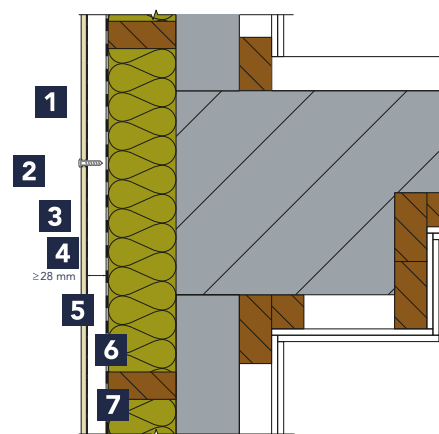

Detail 1-654

- 1** Rockpanel ≥ 8 mm
- 2** Rockpanel Torx screw
- 3** EPDM gasket
- 4** Timber battens
- 5** Breathable membrane
- 6** Insulation (for example ROCKWOOL)
- 7** Horizontally laid timber batten

Roofline

New build

Mechanically fixed to timber supports, fascia board new build

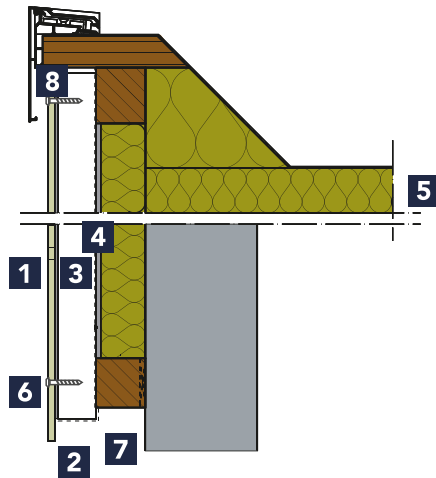

Detail 1-501

- 1** Rockpanel 6 or 8 mm
- 2** EPDM gasket
- 3** Battens ≥ 28 mm
- 4** Breathable membrane
- 5** Insulation (for example ROCKWOOL)
- 6** Rockpanel ring shank nail or screw
- 7** Ventilation profile
- 8** Ventilation joint

Mechanically fixed to timber supports, soffit board new build

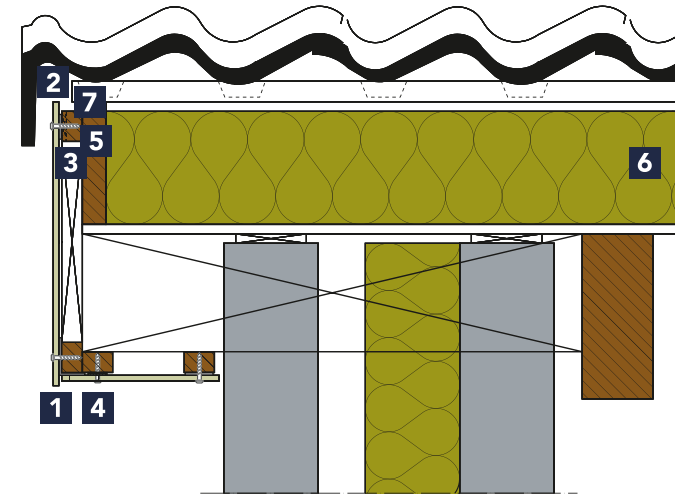

Detail 1-509

- 1** Rockpanel 6 or 8 mm
- 2** Ventilation joint
- 3** EPDM gasket
- 4** Rockpanel screw
- 5** Battens
- 6** Insulation (for example ROCKWOOL)
- 7** Ventilation gap in horizontal battens

Roofline

Renovation

Mechanically fixed to timber supports, fascia board renovation

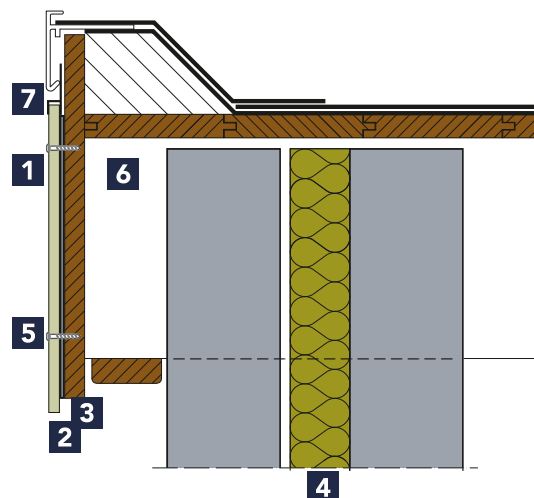

Detail 1-504B

- 1** Rockpanel 6 or 8 mm
- 2** EPDM foam gasket
- 3** Timber fascia board (in healthy condition)
- 4** Insulation (for example ROCKWOOL)
- 5** Rockpanel screw
- 6** Ventilation
- 7** Chair profile

Mechanically fixed to timber supports, soffit board renovation

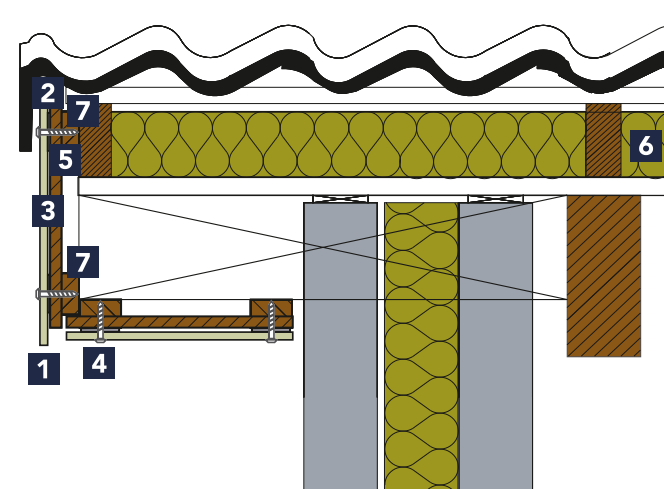

Detail 1-511

- 1** Rockpanel 6 or 8 mm
- 2** Ventilation (existing)
- 3** EPDM foam gasket
- 4** Rockpanel screw
- 5** Existing multi-ply cladding (in healthy condition)
- 6** Insulation (for example ROCKWOOL)
- 7** Ventilation gap in horizontal battens

Attention:

An EPDM foam gasket should be provided to ensure watertight connections at the point where the Rockpanel sheet is fixed over the existing subframe.

Detailing

Non-ventilated applications

Mechanically fixed to timber support, non-ventilated infilling

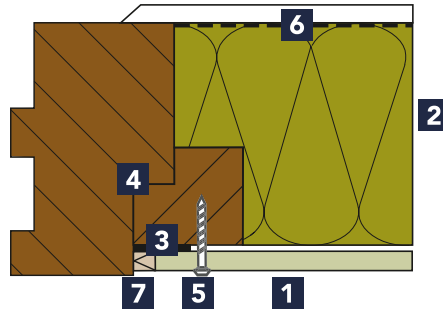

(horizontal)

Detail 1-400

- 1** Rockpanel Colours (without ProtectPlus) 6 or 8 mm
- 2** Insulation (for example ROCKWOOL)
- 3** Non-sticking layer, for example PE-foil
- 4** Battens
- 5** Rockpanel screw
- 6** Vapour barrier, $s_d > 10$ m
- 7** Sustainable weather resistant and elastic sealant

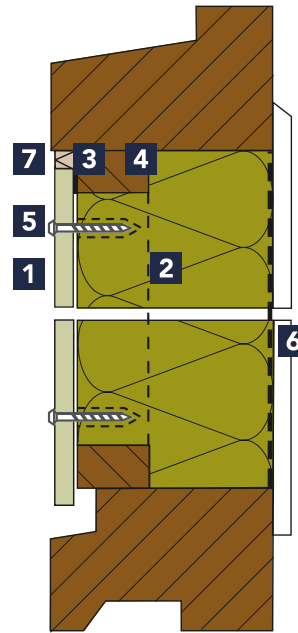

(vertical)

Detail 1-450

Attention:

Pre-conditions for non-ventilated applications see page 107.

**rockpanel.
co.uk**

The Rockpanel website is designed to be an easy-to-use resource for those wishing to find out more about our products. Its clear navigation ensures that you have access to a wealth of information and your questions can be answered.

Specifications

Select the relevant specification along with the selected material to match your product finish, colour and accessory requirements. All specifications are downloadable on www.rockpanel.co.uk.

Building Information Modelling

Building Information Modelling (BIM) is an important aspect of the planning and implementation of construction projects. In order to help with this process, the Rockpanel website provides BIM data files for the full range of our sustainable facade panels, which you can access and insert into digital building models. The BIM data files can be downloaded from the website.

CAD drawings

Rockpanel offers a wide range of CAD drawings online. The drawings are easy to download in PDF, DXF and DWG files and illustrate clearly how specific design details can be produced.

Sample request

On the Rockpanel website www.rockpanel.co.uk you can easily request your sample.

References

- Register to receive 4 e-mails a year containing Rockpanel reference projects from across the globe.
- Go to the "Inspiration" section on our website for more stimulating projects!

ETA and CE marking

With regard to the EOTA procedure for innovative products, Rockpanel boards have been evaluated and approved in accordance with the European Assessment Document (EAD) no. 090001-00-0404. On the basis of this guideline Rockpanel products have received a European Technical Assessment (ETA).

With regard to the ETA all products have a declaration of performance and CE marking thereby fully complying with the construction product regulations in the UK and Europe.

ETA and description:

- ETA-18/0883:
Rockpanel Premium A2 11 mm
- ETA-13/0340:
Rockpanel Colours and ProtectPlus A2 9 mm
- ETA-07/0141:
Rockpanel Colours and ProtectPlus Durable 8 mm
- ETA-08/0343:
Rockpanel Colours Durable 6 mm
- ETA-13/0648:
Rockpanel Durable Natural 10 mm
- ETA-13/0204:
Rockpanel Lines² 8 and 10 mm
- ETA-13/0019:
Rockpanel Ply 8 mm and 10 mm
- ETA-17/0619:
Rockpanel Uni 6 mm



The greatest possible care has been taken in the design and composition of this guide. Nevertheless, we cannot guarantee the completeness and correctness of the information included herein. Price and product changes are reserved. Illustrations, colours, descriptions and information relating to dimensions, characteristics etc. apply only by approximation and are not binding. All of the information in this guide is protected by copyright. This guide, the texts, photos, other information included therein and/ or parts thereof may not be reproduced, modified or published without the prior written approval of Rockpanel.

Feature	Note	PLANKS			BASIC APPLICATIONS		NATURE FACADES		
		Rockpanel Lines ²	Rockpanel Uni	Rockpanel Ply	Rockpanel Natural	Rockpanel Woods	Rockpanel Stones		
APPLICATION									
High facades*	Height > 18 m					■	■	■	
Low facades	Height < 10 m	■	■	■	■		■	■	■
Detailed solutions for roofs		■	■	■					
AESTHETICS									
Type of cladding									
Board			■	■	■	■	■	■	■
Tongue and groove		■							
Weatherboarding	(EasyFix only for Durable or two visible attachments)						■	■	■
Dimensions									
Standard dimensions (mm)	2500x1200/3050x1200		■	■	■	■	■	■	■
Standard dimensions (mm)	3050x164/3050x295	■							
Customised dimensions						■ optional	■ optional	■ optional	
Special width (mm)	1250					■	■	■	
Thickness (mm)		10	6	8 & 10	10		8	8	
Surface									
Untreated						■			
Primer		■		■					
Coloured surface		■	■					Woods look	Stone look
Customised surface									
ProtectPlus protective coating	Matt						■	■	■
ProtectPlus protective coating	Silk matt								
ProtectPlus protective coating	High gloss								
Maintenance									
Can be painted		■	■ light		**	***			
Self-cleaning							■	■	■
Fixing methods									
Invisible fixing	Mechanically	■							
	Adhesive						■	■	■
Screws			■	■	■	■	■	■	■
Nails			■	■	■	■	■	■	■
Rivets						■	■	■	■
FIRE SAFETY									
European fire class	B-s2,d0	■	■	■	■	■	■	■	■
	A2-s1,d0						■ optional	■ optional	■ optional

* For all medium and high rise buildings, we recommend the use of our A2 grade boards (A2-s1,d0).
** Maintenance for Rockpanel Ply depends on the paint chosen. Please contact the paint manufacturer.
*** Rockpanel Natural boards age naturally; for further information see the product data sheet.

DESIGN FACADES

PREMIUM FACADES

Feature	Note	Rockpanel Colours	Rockpanel Colours ProtectPlus	Rockpanel Metals	Rockpanel Chameleon	Rockpanel Premium
APPLICATION						
High facades*	Height >18 m	■	■	■	■	■
Low facades	Height < 10 m	■	■	■	■	■
Detailed solutions for roofs		■	■			
AESTHETICS						
Type of cladding						
Board		■	■	■	■	■
Tongue and groove						
Weatherboarding	(EasyFix only for Durable or two visible attachments)	■	■	■	■	
Dimensions						
Standard dimensions (mm)	2500x1200/3050x1200	■	■	■	■	■
Standard dimensions (mm)	3050x164/3050x295					
Customised dimensions		■ optional	■ optional	■ optional	■ optional	■
Special width (mm)	1250	■	■	■		■
Thickness (mm)		6 & 8	8	8	8	9
Surface						
Untreated						
Primer						
Coloured surface		■	■	■	■	■
Customised surface						■
ProtectPlus protective coating	Matt					■
ProtectPlus protective coating	Silk matt		■	■		■
ProtectPlus protective coating	High gloss				■	■
Maintenance						
Can be painted		■				
Self-cleaning			■	■	■	■
Fixing methods						
Invisible fixing	Mechanically					■
	Adhesive	■	■	■	■	
Screws		■	■	■	■	
Nails		■	■	■	■	
Rivets		■	■	■	■	■
FIRE SAFETY						
European fire class	B-s2,d0	■	■	■	■	
	A2-s1,d0	■ optional	■ optional	■ optional	■ optional	■

BUILDING INSPIRATIONS



www.rockpanel.co.uk

Learn more about us, ask for product samples and be inspired by attractive reference projects.



www.facebook.com/rockpanel

Be the first to discover our latest international projects.



www.twitter.com/rockpanel

Follow us for the latest news and updates.



Engage and interact.



www.instagram.com/rockpanel

Get inspired.