

CEDRAL



The world of Facades

Give your home a timeless facade

- ✓ *factory applied colour*
- ✓ *low maintenance*
- ✓ *easy to install*

www.cedral.co.uk

etex inspiring ways
of living

TIMELESSLY BEAUTIFUL FACADES

Ideal for new-build and renovation projects

A sustainable and contemporary material, Cedral is ideal for renovations and new build projects and can be used across the whole or a part of your house, helping to create a stunning individual look to your home.

Hard as stone, workable as wood

Thanks to the multilayer fibre structure, the fibre cement planks combine the durability of stone with the design flexibility of wood.

The planks are available in a range of colours with a timber effect finish and a modern, textured look.

- | | |
|----------------------------------|---------------------------------|
| 4 The DNA of Cedral | 12 Cedral colours |
| 4 Key benefits | 14 Cedral projects |
| 6 Choose your finish | 22 Installation solution |
| 8 Lap or Click | 25 Ventilation |
| 10 Orientation and colour | 26 Cedral Board |

✓ *low maintenance*

✓ *factory applied colour*

✓ *easy to install*

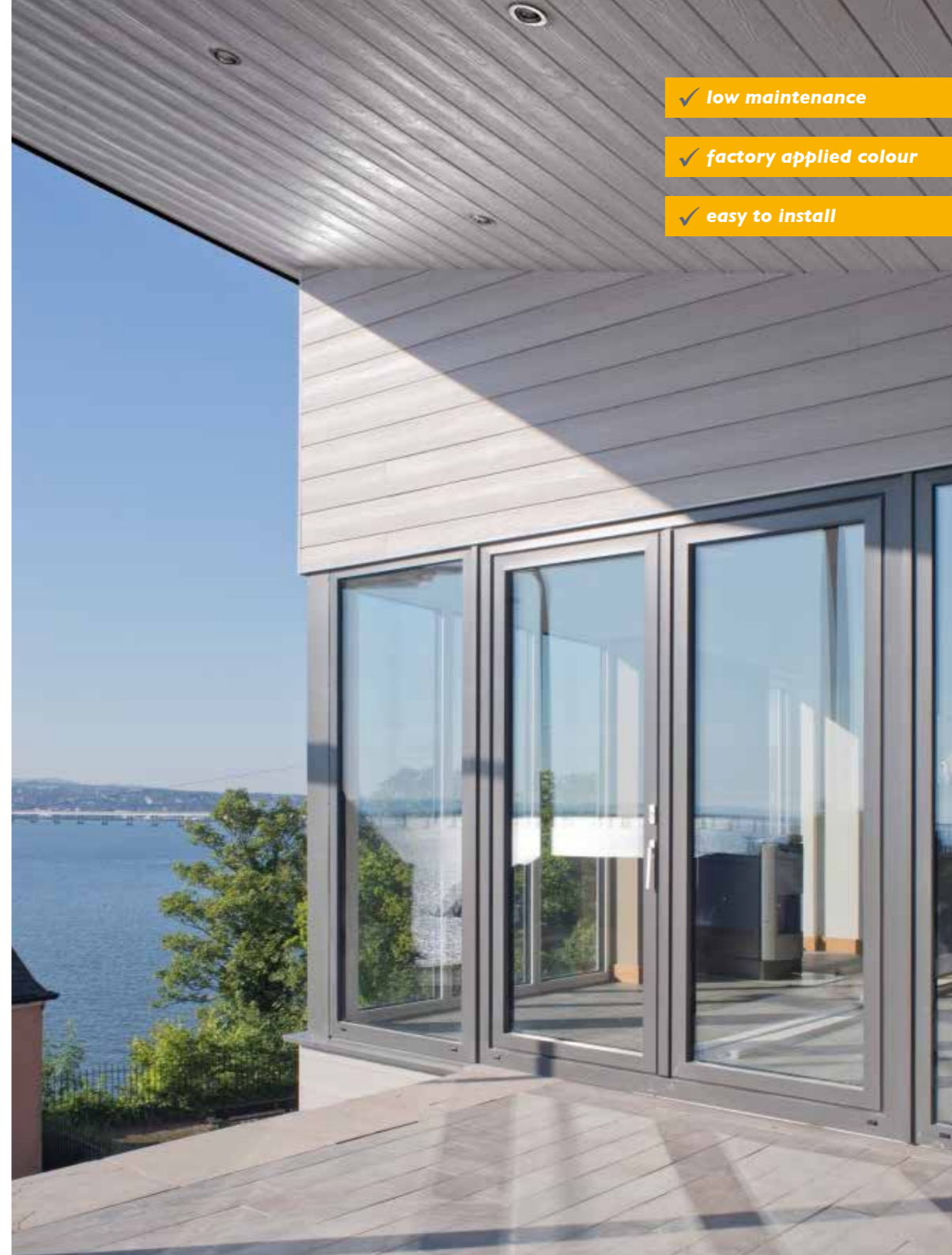

The DNA of Cedral

The natural origins of Cedral

Cedral facade is a high quality and durable fibre cement plank, produced using natural raw materials: cement, water and wood fibres. These planks can create a beautiful contemporary or traditional look that will last a lifetime.



Key benefits

Choose from a range of colours

Cedral planks are available in a wide range of colours and can be placed both vertically and horizontally.

A full range of trims and accessories offers a complete system.

Let your creativity run free and give your house a personal colourful touch.



A durable facade

A Cedral facade helps to protect your home against the harshest weather conditions.

Cedral has excellent water, UV and frost resistant properties.

The fibre cement planks are also resistant to rot and immune to attack by fungi, bacteria, insects and vermin, ensuring your facade will stand the test of time.



Achieves a top fire rating

Did you know that our building materials have an excellent reaction to fire rating. Officially the classification is A2-s1,d0. Being part of the A group means our materials have no restriction on where they can be used, and in some countries can be considered as non-combustible. The s1 rating is the highest level of performance against generating smoke, while the d0 rating means that the material does not produce flaming droplets. In short they are non-flammable.

Perfect for renovation

Fibre cement cladding is the ideal material for the renovation of a facade. It will cover imperfections and protect newly installed insulation, resulting in a professionally finished aesthetic. The cladding is installed to the outside of your home ensuring minimal disruption during your renovation project.



Low maintenance

During production, the Cedral planks are coated with layers of UV resistant paint. The material is dimensionally stable and rot resistant, so does not require regular maintenance. Wash off occasionally with soapy water to help keep your facade looking as good as new.



Easy to install

The support structure for a Cedral facade is simple: vertical battens with a centre-to-centre distance of up to 60 cm. The Cedral range also includes colour matched trims and touch up paint to complete your facade beautifully.

Bespoke screws and clips ensure quick and easy installation, creating a flawless finish.



Choose your finish

**Do you want a timber effect
or a flat, smooth facade?**

All colours are available in a wood effect or a smooth,
modern finish. Please refer to pages 12-13.





CEDRAL LAP



CEDRAL CLICK

Will you go for Lap or Click?



Cedral Lap

Installed in a traditional shiplap style, giving your facade beautiful, deep shadow lines.

Length	3600 mm
Width	190 mm
Thickness	10 mm
Weight per plank	11,2 kg



Cedral Click

The Cedral Click facade is a flush fitting, tongue and groove cladding board, providing a contemporary look to your house.

Length	3600 mm
Width	186 mm
Thickness	12 mm
Weight per plank	12,2 kg





Cedral Click Horizontal
C01 White



Cedral Click Vertical
C03 Brown



Cedral Click Smooth
C05 Grey



Cedral Lap Wood
Van den Berg Kruisheer Effers Architecten
C01 White, C04 Dark Brown,
C61 Burnt Red

Does **horizontal or vertical** suit your project best?

You can install Cedral Lap and Cedral Click horizontally and vertically, in a number of design options.

One colour **or with accents?**

With a Cedral facade, you have the freedom to create stand-out projects.

Choose the right colour for your project

The Forest range

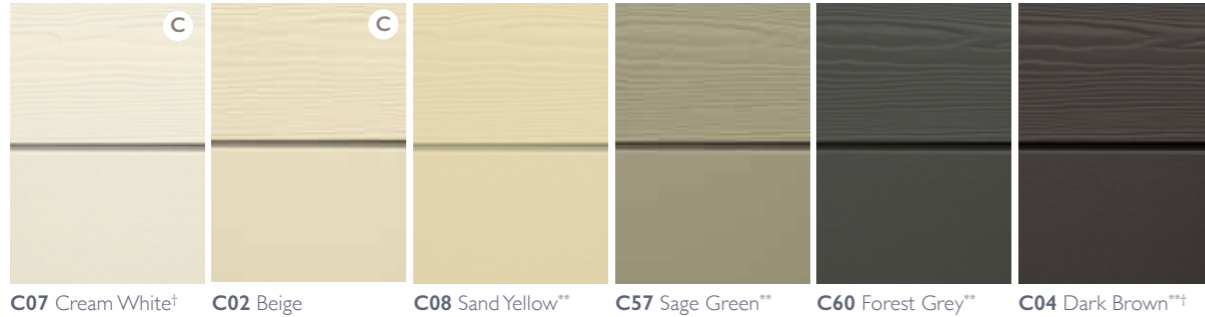

The Mineral range

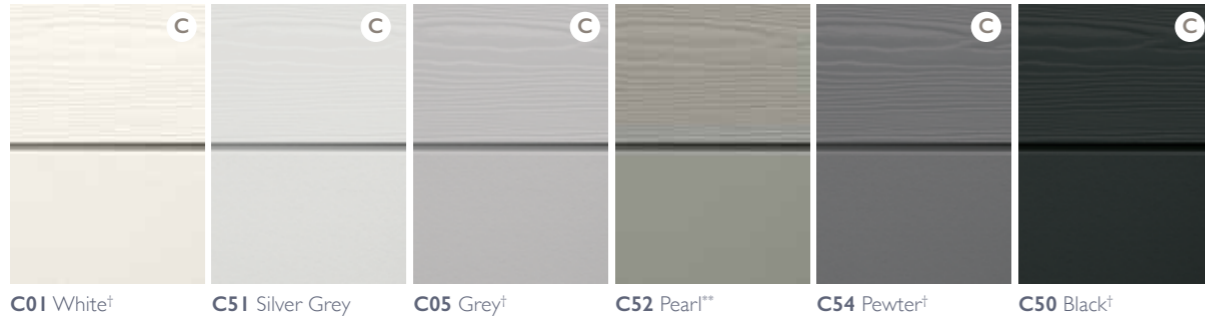

Cedral Lap can be supplied in a range of 21 factory applied colours and 2 woodstain finishes providing an aesthetic option to suit most project requirements.

Cedral Click and Cedral Click Smooth finishes can be supplied in a range of 7 factory applied colours. Other colours within the range, bespoke colours and Cedral Click Smooth are subject to minimum order quantities and extended lead times.

For your nearest stockist, visit cedral.co.uk

The Earth range



The Ocean range

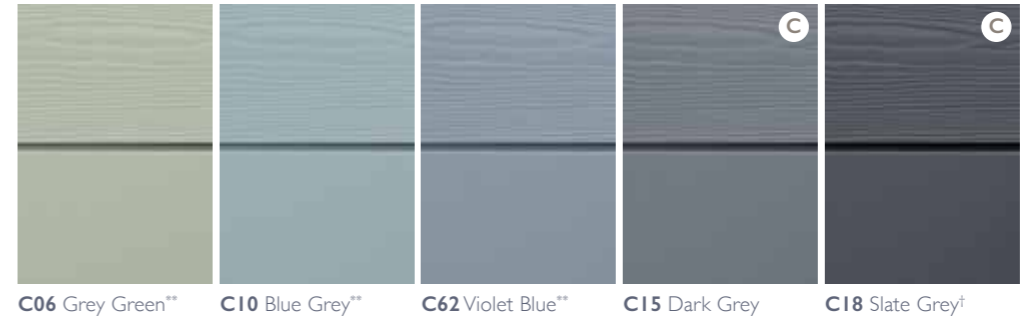

Cedral Board

Cedral Board is an impact resistant, durable and flat board, ideal for soffits and fascias.

Cedral Board is available in 9 colours and in the following sizes:

- 2500mm x 200mm
- 2500mm x 400mm
- 2500mm x 300mm

C Cedral Click and Cedral Click Smooth standard factory-applied colour range.

* Not available for Cedral Click or Cedral Click Smooth.

** Cedral Click and Cedral Click Smooth may be subject to minimum order quantities and extended lead times.

† Cedral Board is available in these colours.

‡ Cedral Lap in Light Oak and Dark Oak is designed to mimic the appearance of stained natural wood and, as such, a variation in the colour and shade is part of the effect inherent in the material design.



Please note: the colour photographs above are for reference only and we recommend you request a sample.

Cedral facade projects

Private house
Cedral Lap Wood
C05 Grey



Private lakeside dwelling
Architectural firm S.H.M. van der Linde BV
Cedral Click Wood
C04 Dark Brown





Private house

Cedral Lap Wood
C50 Black



Private house

Architect: Blackdog Architects
Cedral Click Wood
C01 White





Private house
 Architect: Scandia Hus
 Cedral Click Wood
 C05 Grey



Private house
 Architect: Trevor Irvin
 Cedral Lap Wood
 C01 White





Private house

Cedral Lap Wood
C03 Grey Brown C50 Black



Period house

Architectural contrast on new extension
Cedral Click Smooth
C05 Grey

Complete installation solutions

Cedral Click

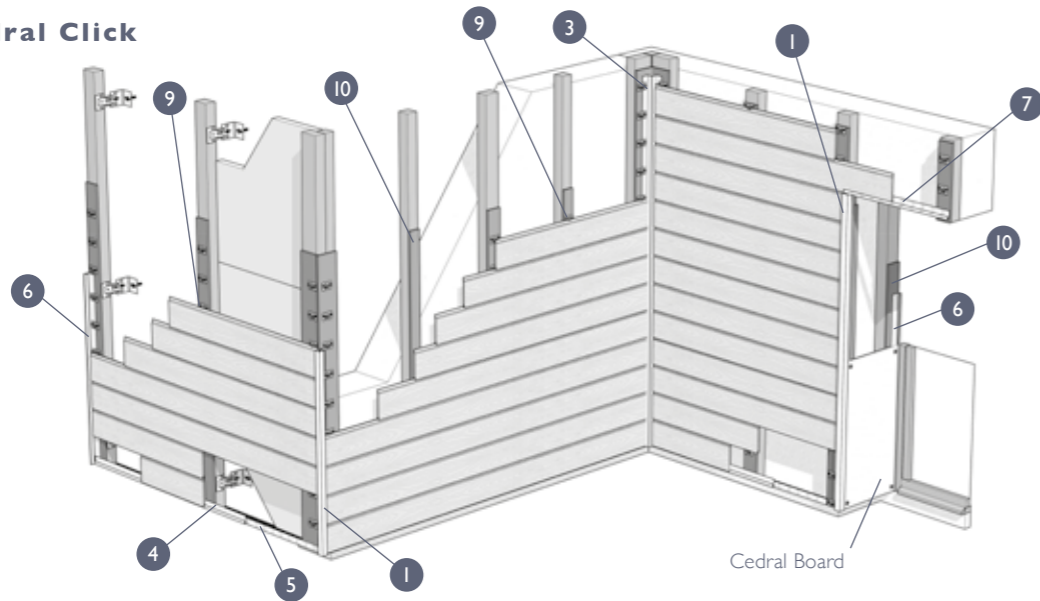

Cedral Lap

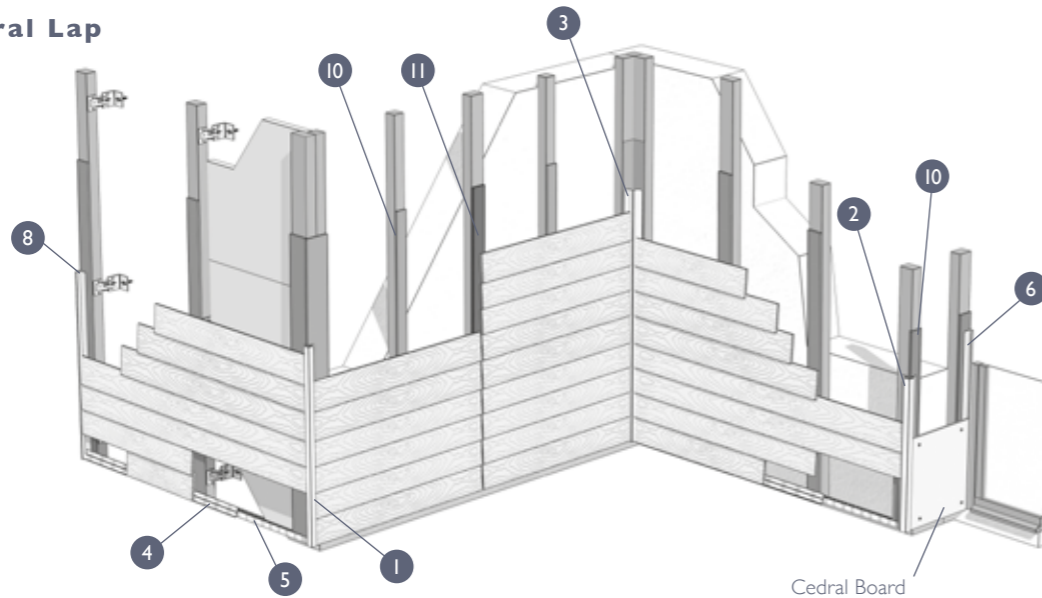



Aluminium profiles and accessories

We offer a complete range of colour matched aluminium profiles for Cedral Lap and Cedral Click.

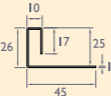
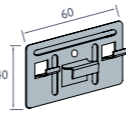
Dimensions in mm.	Cedral Lap	Cedral Click
1 External corner (symmetrical) This profile can be used as finishing external corners. Length 3 m.		
2 External corner (asymmetrical) This profile can be used as finishing external corners. Length 3 m.		Not required for Click
3 Internal corner To finish the corner where Cedral meets on an internal corner, forming a seal between the trim and the corner. Length 3 m.		
External Corner Junction Used as a corner joining piece. Only available in black. Length 300 mm.		
4 Start profile horizontal installation Used to start a horizontal cladding run of the façade planks. Length 3 m.		
Start profile vertical installation Used to start a vertical cladding run. Length 3 m.	Does not apply	
5 Perforated closure Shields the air cavity against pest infestation and debris. Finish in aluminium or black lacquered aluminium. Length 2.5 m.		
6 Connection profile End trim to finish Cedral when used as a single piece on a window reveal or soffit. Length 3 m.		

Dimensions in mm.	Cedral Lap	Cedral Click
<p>7 Lintel profile for window Used to finish the cladding above the window and to support the next course of Cedral Click. Length 3 m.</p>	Does not apply	
<p>8 End profile Hides any sharp corners and protects the Cedral edges from wear and tear. Length 3 m.</p>		Does not apply
<p>9 Cedral Click Clip and screws</p>	Does not apply	

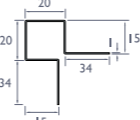
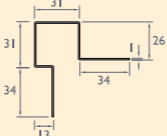
Cedral Board profiles and accessories

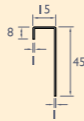
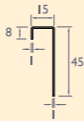
Dimensions in mm.	Cedral Lap	Cedral Click
<p>1 External corner Cedral Click Can be used as an external corner profile when finishing around a window or when using as a soffit or fascia.</p>	Does not apply	
<p>2 External corner (asymmetrical) Can be used as an outer corner profile when finishing a window with Cedral Board in combination with Cedral Lap.</p>		Does not apply
<p>Ventilation profile Provides ventilation behind Cedral Board and the sealing of the joints at eaves and buoy edges.</p>		Does not apply
<p>6 Connection profile End trim to finish Cedral when used as a single piece on a window reveal or soffit.</p>		

The importance of ventilation

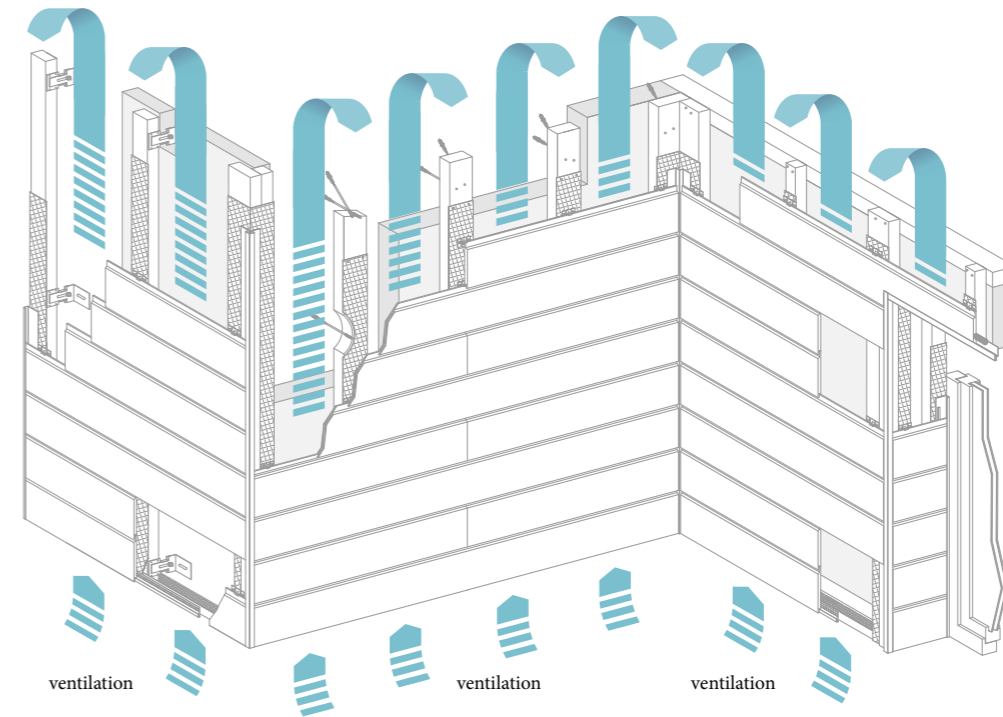

To ensure the best results and longevity of your facade, you must always have good ventilation

Use a perforated closure at the bottom and top of the facade, above doors and above and below windows.

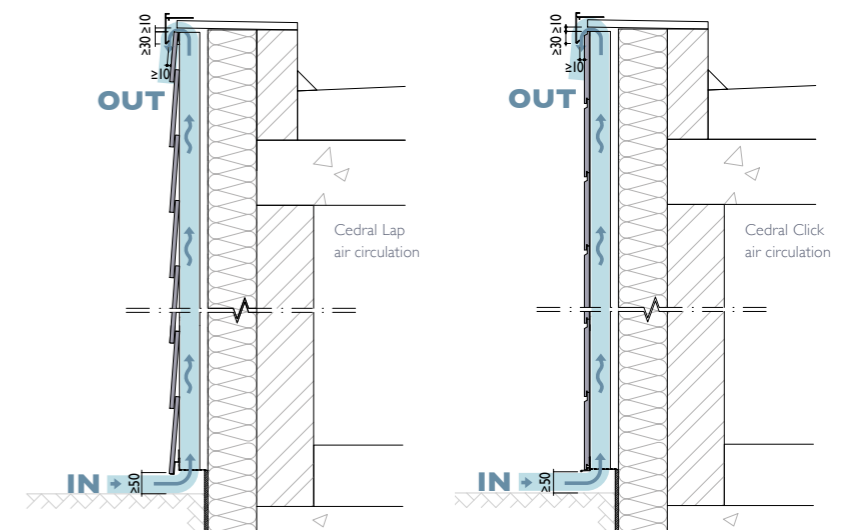

* Colour matched, mushroom head Cedral screws and retouch paint are also available. For more information, download the Cedral Installation Guide at www.cedral.co.uk



Cedral Board used as fascias and soffits



Cedral Board as gutter cover

Cedral Soffit and Fascia Board The perfect finish

To perfectly complement your home, Cedral also offers Cedral Soffit and Fascia Board in the same painted colours as Cedral Lap and Cedral Click.

This publication is based on the latest data available at the time of printing. Due to product changes, improvements and other factors, the Company reserves the right to change or withdraw information contained herein without prior notice. For specific applications users should refer to the Technical Support Department and relevant Standards and Codes of Practice for guidance. The photography shown in the document should not necessarily be taken as recommendations of good practice. The printing process restricts the exact representation of colours. For true colour reference, please request product samples.

This document is protected by International copyright laws. Reproduction and distribution in whole or in part without prior written permission is strictly prohibited. Cedral is a registered of Etex NV or an affiliate thereof. Any use without authorisation is prohibited and may violate trademark laws.

CEDRAL



The world of Facades



Do you need a free
colour sample?

Are you looking for a
Cedral facade installer?

Do you want a quote from
a stockist or professional
in your area?

For all this and more, visit
www.cedral.co.uk



more at cedral.co.uk

Tel 01283 501555 Email infouk@etexgroup.com

Etex (Exteriors) UK, Wellington Road, Burton-upon-Trent, Staffordshire DE14 2AP

etex inspiring ways
of living